

INSTRUCTION MANUAL

Serial Number _____

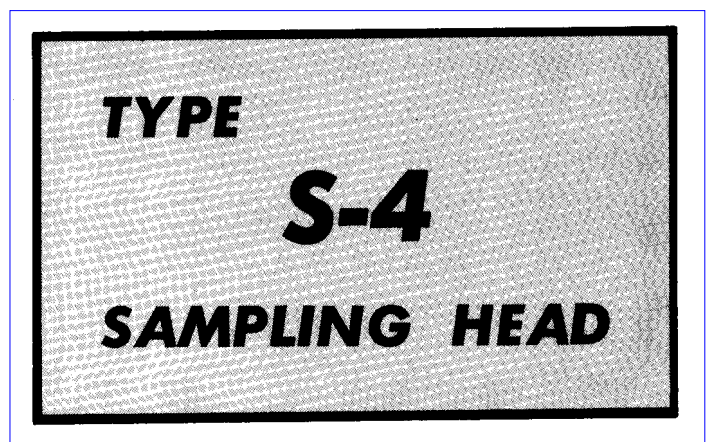

Tektronix, Inc.

S.W. Millikan Way ● P. O. Box 500 ● Beaverton, Oregon 97005 ● Phone 644-0161 ● Cables: Tektronix
070-0896-00



WARRANTY

All Tektronix instruments are warranted against defective materials and workmanship for one year. Tektronix transformers, manufactured in our plant, are warranted for the life of the instrument.

Any questions with respect to the warranty mentioned above should be taken up with your Tektronix Field Engineer.

Tektronix repair and replacement-part service is geared directly to the field, therefore all requests for repairs and replacement parts should be directed to the Tektronix Field Office or representative in your area. This procedure will assure you the fastest possible service. Please include the instrument Type and Serial or Model Number with all requests for parts or service.

Specifications and price change privileges reserved.

Copyright © 1969 by Tektronix, Inc., Beaverton, Oregon. Printed in the United States of America. All rights reserved. Contents of this publication may not be reproduced in any form without permission of the copyright owner.

CONTENTS

Section 1	Specification
Section 2	Operating Instructions
Section 3	Circuit Description
Section 4	Maintenance
Section 5	Performance Check/Calibration
	Abbreviations and Symbols
	Parts Ordering Information
Section 6	Electrical Parts List
	Mechanical Parts List Information
Section 7	Mechanical Parts List
Section 8	Diagrams
	Mechanical Parts List Illustrations
	Accessories

Abbreviations and symbols used in this manual are based on or taken directly from IEEE Standard 260 "Standard Symbols for Units," MIL-STD-12B and other standards of the electronics industry. Change information, if any, is located at the rear of the manual.

SEE PARTS LIST FOR SEMICONDUCTOR TYPES

SERIES M MODEL 1, 2, 3

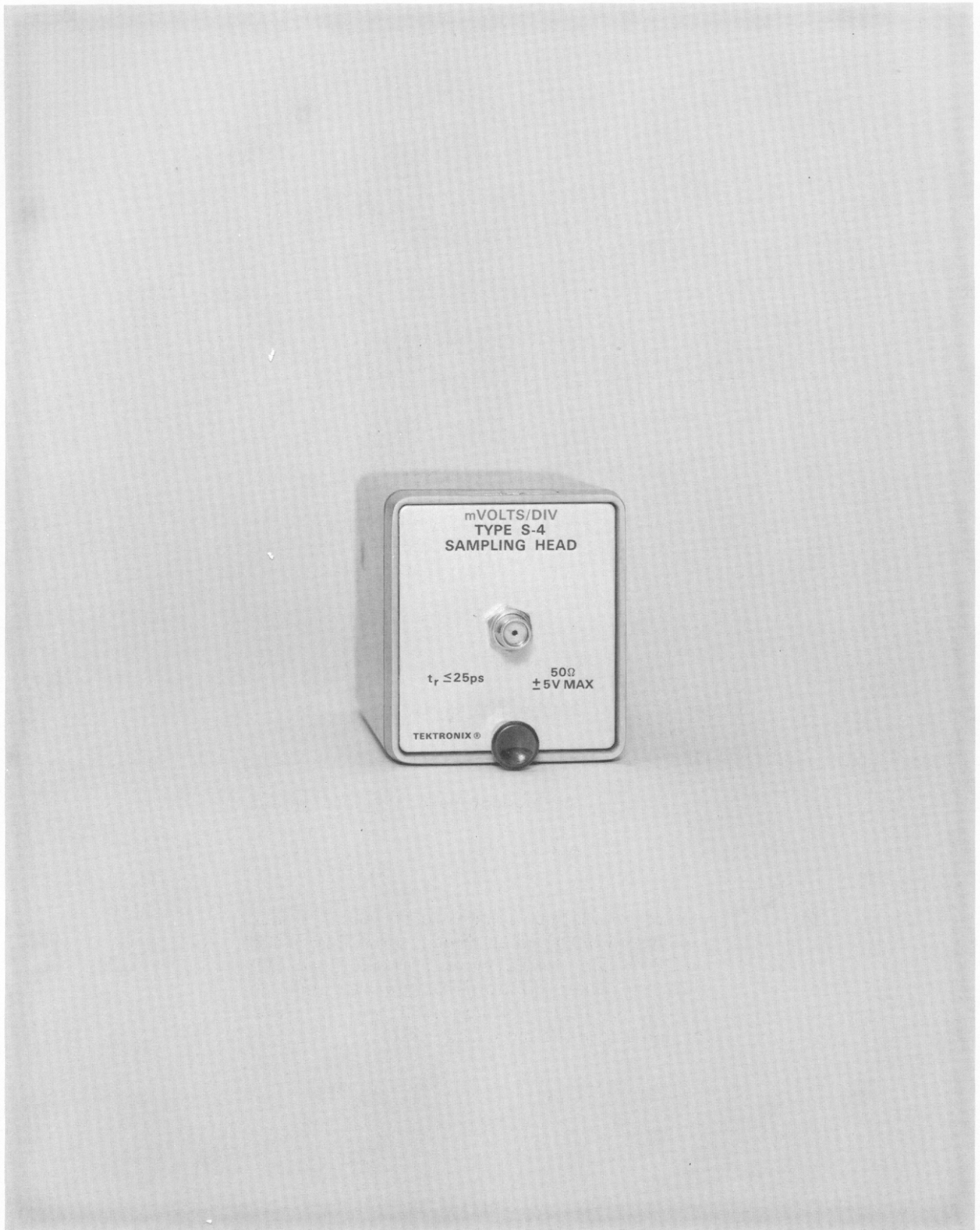

Fig. 1-1. Type S-4 Sampling Head.

SECTION 1

TYPE S-4 SPECIFICATION

Change information, if any, affecting this section will be found at the rear of the manual.

General Information

The Type S-4 Sampling Head is an input signal processing unit for Tektronix sampling units such as the Type 3S2, 3S5, and 3S6. Input characteristics of the sampling system are determined by the Type S-4. The Type S-4 has an input impedance of 50 Ω and a risetime of 25 ps or less.

The Type S-4 can be installed directly into a sampling unit or used remotely (with the Type 3S2 or Type 3S5) on an optional 3 foot or 6 foot extender cable. When used with a Type 3S6 Sampling Unit the Type S-4 is plugged into the dual-input extender cable supplied with the Type 3S6.

A portion of the signal delivered to the sampling head input is coaxially coupled to the sampling unit for use as an internal trigger signal. The Type 3S2 allows selection of the trigger pickoff signal from the Channel A or Channel B sampling head. Type 3S5 and 3S6 Sampling Units permit use of the trigger pickoff signal only from Channel A. Use of this trigger pickoff signal is dependent upon the type of sampling unit and sampling sweep unit used in the system. See the instruction manual for your sampling unit and sampling sweep unit for further information.

Vertical deflection factor of the sampling system is labeled at the top of the Type S-4 as mVOLTS/DIV; the label refers to the sampling unit Units/Div switch of the corresponding channel.

Digital Unit Programming Connections

The Type S-4 has two contacts at its rear connector that program the decimal and units-of-measure lamps of a Tektronix Type 6R1A or Type 230 Digital Unit. These connections are not used with a Type 3S2 Sampling Unit. When using a Type 3S5 or Type 3S6, one of the sampling head contacts notifies the digital readout unit, through the sampling unit digital control circuits, that the Type S-4 is a voltage measuring head. This causes the Volts lamp of the digital readout unit to light. The other sampling head contact notifies the digital readout unit, through the sampling unit digital control circuits, that the Type S-4 sensitivity requires no decimal shift of the numbers around the sampling unit Units/Div switch.

ELECTRICAL CHARACTERISTICS

Characteristics

The following characteristics apply over an ambient temperature range of 0°C to +50°C and after a five minute warmup providing the instrument was calibrated at a temperature between +20°C and +30°C.

Characteristics listed below apply only after the Type S-4 has been properly mated to the sampling unit and indicator oscilloscope and after these units have been given sufficient

warmup time. To determine the particular system warmup requirements, refer to the related amplifier and indicator oscilloscope instruction manual. A procedure for mating the Type S-4 to the sampling unit can be found in the Operating Instructions section of this manual

ELECTRICAL CHARACTERISTICS

Characteristic	Performance Requirement
Input Resistance	50 Ω within 5%
Response to Step Signals	
Risetime (10% to 90%)	25 ps or less (Verify using step 9, Section 5.)
Pulse Flatness Deviation (after 90% point on display) 0 ps to 400 ps	—10% to +10% with a total of 20% or less. (Verify using step 10, Section 5).
400 ps to 25 ns	0% to +10% with a total of 10% or less. (Verify using step 10, Section 5).
25 ns or more	—2% to +2% with a total of 4% or less. (Verify using step 10, Section 5).
Maximum Operating Signal Voltage	1 V P-P
Safe Overload Signal Voltage	Not to exceed + or —5 V (DC plus AC peak)
Loop Gain	Adjustable in the sampling unit to unity for signals up to 500 mV P-P; when the loop gain is adjusted to unity with positive input signals, the loop gain will be within 5% of unity with negative input signals and vice versa.
Baseline Shift (with change in repetition rate)	10 mV or less, 30 Hz to 50 kHz
Displayed Noise	5 mV or less, measured tangentially

ENVIRONMENTAL CHARACTERISTICS

Storage	Operating
Temperature— —40°C to +65°C	Temperature—As stated above Electrical Characteristics table
Altitude—To 50,000 feet	Altitude—To 15,000 feet

Specification—Type S-4

MECHANICAL CHARACTERISTICS

Dimensions— Height \approx 2 inches
 Width \approx $1\frac{7}{8}$ inches
 Length \approx $4\frac{1}{8}$ inches
Construction— Epoxy laminated circuit boards. Aluminum

wrap around cabinet with aluminum casting at front and rear. Anodized aluminum front panel.

Accessories— An illustrated list of the accessories supplied with the Type S-4 is at the end of the Mechanical Parts List pullout pages.

SECTION 2

OPERATING INSTRUCTIONS

Change information, if any, affecting this section will be found at the rear of the manual.

General Information

This section provides the basic information required for operation of the Type S-4 Sampling Head, including installation and First Time Operation.

The Type S-4 can be used on an extender cable without compromising the response of the measurement system. Signals are applied to the 50 Ω input of the sampling head through a 3 mm, 50 Ω coaxial connector located at the center of the front panel.

Unity loop gain can be obtained with input signals of up to 0.5 volt (peak-to-peak). Unity loop gain ensures the most accurate displays, of particular importance during fast changes in input signal amplitude. See the Basic Sampling Principals Section of your sampling unit manual for further information.

The Type S-4 may be used with input signals up to 1 volt (peak-to-peak). Specifications for the Type S-4 Sampling Head are given in Section 1 of this manual.

NOTE

Attenuators, with threaded 3 mm connectors, are available as optional accessories. These attenuators are useful in reducing the amplitude of large signals. Other optional accessories with 3 mm connectors include coaxial cables, a 50 Ω termination, and adapters for interconnecting various types of connectors. Refer to your Tektronix catalog or contact your local Tektronix Field Engineer or Representative for further information about optional accessories.

Installing the Type S-4 Sampling Head

Fig. 2-1 shows the Type S-4 partially installed in a Type 3S2 Sampling Unit with a Type 564 Oscilloscope and a Type 3T2 Random Sampling Sweep unit. The sampling head (or heads) can be plugged into the sampling unit as shown, or used remotely on a special extender cable. Three and six foot extender cables are available. Order the three foot extender cable by Tektronix Part No. 012-0124-00, or the six foot extender cable by Tektronix Part No. 012-0125-00. Contact your local Tektronix Field Engineer or Representative for price and availability of these optional accessories.

To insert the Type S-4 into a compartment of the sampling unit, proceed as follows:

1. Pull the latch knob (Fig. 2-1) outward from the front panel (the latch knob will push out normally when the unit is inserted if the knob is left free to move).
2. Insert the Type S-4 slowly into the compartment, so the two plastic guides in the compartment engage the S-4.

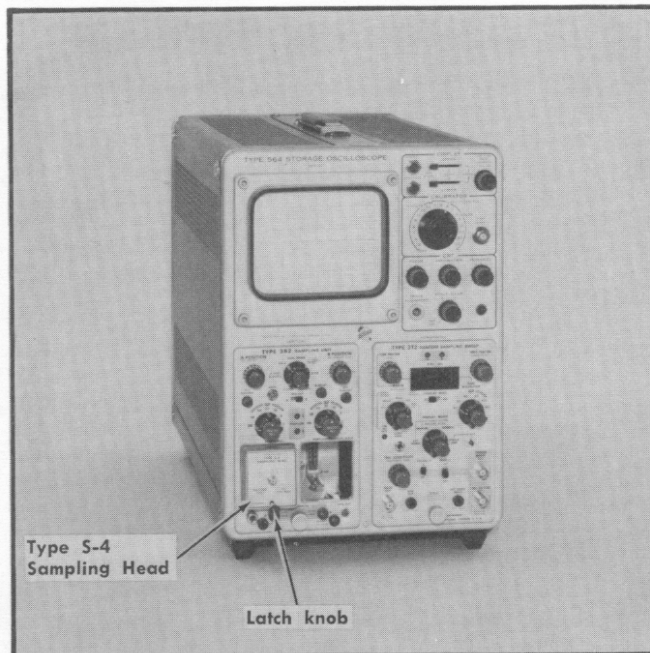

Fig. 2-1. Inserting the Type S-4 Sampling Head in the sampling unit.

3. Push the Type S-4 completely into the compartment.
4. Push the latch knob to lock the Type S-4 in place.

To remove the Type S-4 from the compartment, pull the latch knob away from the front panel, then pull the unit from the compartment.

To use the Type S-4 on an extender cable, install as follows:

1. Pull the latch knob located on the head end of the extender cable outward from the panel (the latch knob will push out normally when the extender is inserted if the knob is free to move).
2. Insert the extender cable head end slowly into the desired compartment in the sampling unit so the two plastic guides in the compartment engage the unit.
3. Push the head completely into the compartment.
4. Push the latch knob to lock the extender cable head end in place.
5. Connect the Type S-4 to the other end of the extender cable in a similar manner, and set the latch knob to hold it in place.

Operating Instructions—Type S-4

6. To remove the Type S-4 from the extender cable, pull the latch knob on the front panel of the Type S-4, and remove the unit from the extender cable.

7. To remove the extender cable head from the sampling unit compartment, pull the latch knob outward from the front of the panel, then pull the unit free.

Mating

The vertical deflection factor and the sampling system loop balance (adjusted by the Gate Bal control) should be adjusted when mating a Type S-4 to a sampling unit.

The mVOLTS/DIV label on the Type S-4 names the deflection factor units of the sampling unit Units/Div switch. For example, with the Type S-4 installed in a Type 3S2 and the Units/Div switch set at 100, each major division of CRT deflection corresponds to 100 millivolts of input signal (when the Variable control is in the Cal position). The deflection factor is mated to the indicator oscilloscope CRT by adjusting the sampling unit Gain control. Refer to the sampling unit manual for its Gain adjustment.

The Gate Balance adjustment of the Type S-4 is not greatly affected when the sampling head is changed from one sampling unit to another, or is operated on an extender cable. However, for precise offset measurements, the Gate Balance control must be readjusted whenever such a relocation is made. Location of the control and details of its adjustment are given below under the heading First Time Operation.

FIRST TIME OPERATION

In addition to the Type S-4, this procedure utilizes a Type S-50 Pulse Generator, Type 3S2 Dual-Trace Sampling Unit, Type 3T2 Random Sampling Sweep, and a Type 564 Storage

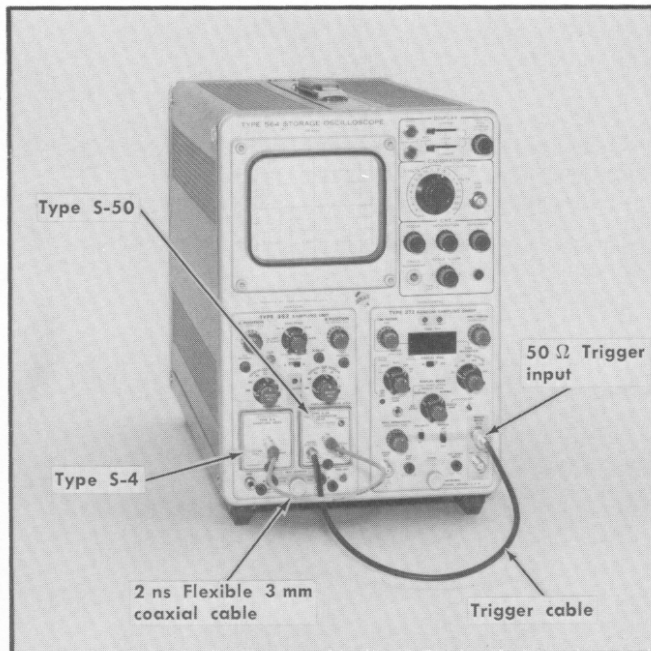

Fig. 2-2. Equipment setup used during First-Time Operation.

Oscilloscope. See Fig. 2-2. The Type 3T2 Random Sampling Sweep permits viewing the signal in advance of the triggering event. Such sampling sweep trigger lead-time is required when using the Type S-4 with the Type 3S2 for viewing fast pulses without a pretrigger. The built-in pretrigger circuit of the Type S-50 permits sequential sampling units, such as the Type 3T5 or Type 3T6, to operate at their faster sweep rates.

Setup Information

1. With the Type 564 Power switch off, insert a Tektronix Type 3S2 Sampling Unit into the vertical channel compartment (left) and a Tektronix Type 3T2 Random Sampling Sweep unit into the horizontal channel compartment.

2. Insert the Type S-4 into the Channel A compartment (left) of the Type 3S2 leaving the latch knob free to move. Once the S-4 is seated, push the latch to lock it in place.

3. Insert the Type S-50 into the Channel B compartment (right) of the Type 3S2 leaving the latch knob free to move. Once the S-50 is seated, push the latch to lock it in place.

4. Connect the Type S-50 output connector to the Type S-4 input connector using a 2 ns section of flexible coaxial line. See cable bending limits discussed under Cable and accessory Considerations later in this section.

NOTE

Connectors at both ends of the coaxial cable should be firmly connected to mating connectors or accessories. Tighten slightly more than finger tight using a $\frac{5}{16}$ inch wrench. A good connection is necessary to minimize reflections at the junction of connectors.

5. Connect Pretrigger Out of the Type S-50 to the 50 Ω Trigger Input of the Type 3T2.

6. Set the Intensity control on the Type 564 fully counter-clockwise.

7. Connect the Type 564 to the power line and set the Power switch to On.

8. Allow about 5 minutes warmup so the units reach operating temperature before proceeding.

9. Set instrument controls as follows:

TYPE 3S2

Display Mode	CH A
Normal-Smooth	Normal
Horiz Compatibility Sw.	Sampling
Channel A controls	
Position	Midrange
DC Offset	Midrange (5 turns from one end)
Units/Div	200
Variable	Cal
Invert	Push in
Dot Response	Midrange

TYPE 3T2

Time Position	Midrange
Horiz Position	Midrange
Samples/Div	9 o'clock position
Samples/Div Sw	Variable
Display Mode	Normal
Start Point	Before Trigger
Sweep Rate	100 ns/Div
Range	1 μ s
Display Mag	$\times 1$
Time Magnifier	$\times 1$
Variable	Cal
Trigger Source	Ext
Trig. Sensitivity	Fully clockwise

TYPE 564

Astigmatism	Midrange
Focus	Midrange
Intensity	Fully counterclockwise
Upper and Lower Screen	Non-Store

10. Advance the Type 564 Intensity control until the trace brilliance (free running sweep) is at the desired viewing level. Adjust Astigmatism and Focus controls.

11. Center the trace on the graticule with the Type 3S2 "A" Position control and/or the DC Offset control.

12. Adjust the Type 3T2 Trigger Sensitivity and Time Position controls for a stable triggered display of the Type S-50 output pulse. See Fig. 2-3A (displayed signal amplitude has been adjusted to 5 divisions by turning the Type 3S2 Channel A Variable control).

Display Characteristics of Fastrise Input Pulses

In Fig. 2-3A the displayed pulse shows overshoot at the end of the fastrise portion of the pulse. This overshoot is normal when using the Type S-4 together with a fastrise pulse generator such as the Type S-50. Since the 0% to 100% amplitude of the pulse is 5 divisions, each division represents 20%. In Fig. 2-3A the overshoot appears to have an amplitude of approximately 0.4 divisions or 8%.

The preshoot portion of the Type S-50 output pulse is the relatively slow rise signal driving the Type S-50 output tunnel diode. The fastrise portion occurs as the output tunnel diode switches. Thus, the region labeled as the preshoot portion of the pulse in Fig. 2-3A is apparently much slower than the fastrise portion. The presence of several dots indicates samples taken during the preshoot, and the absence of samples during the fastrise portion indicates the difference in risetime. The appearance of these portions of the Type S-50 output pulse at a faster sweep rate is shown in Fig. 2-3B.

Set Type 3T2 Range switch at 100 ns and Time Magnifier to X10. Set the Type 3T2 Start Point switch to With Trigger. Turn the Type 3T2 Time Position control until a display similar to that of Fig. 2-3B is visible. This waveform shows that after a rather gradual rise requiring about 5 ns (5 divisions)

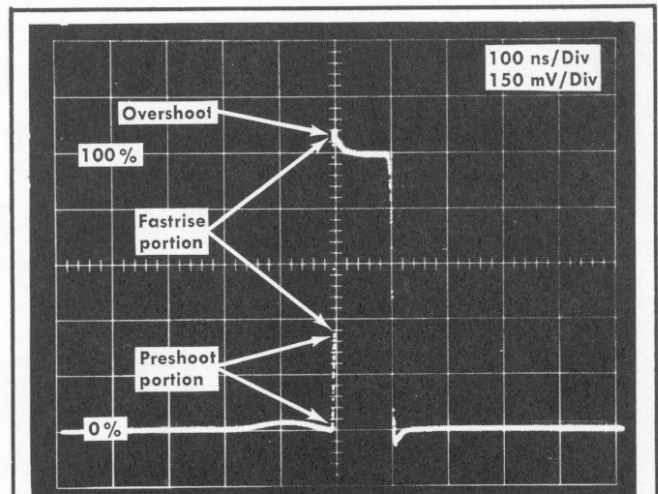

(A) Overshoot of displayed fastrise signal.

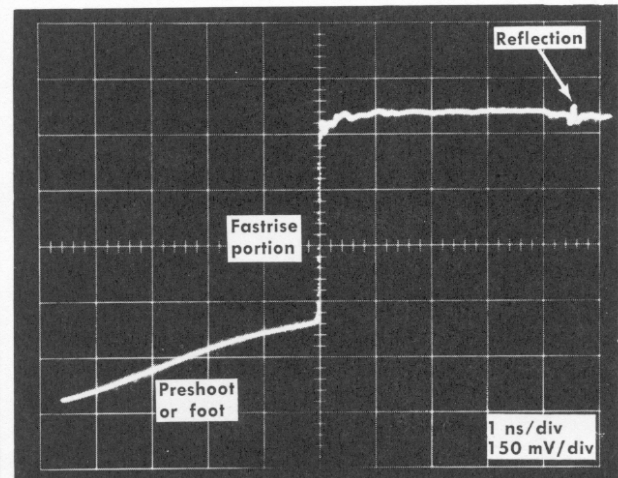

(B) Preshoot and fastrise portions of an input signal.

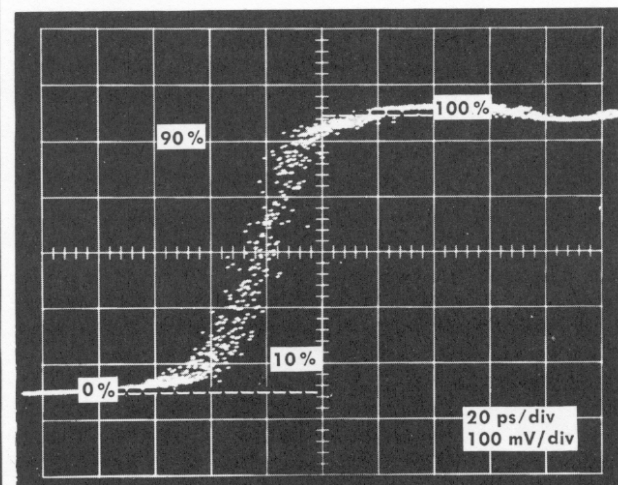

(C) Determining displayed risetime.

Fig. 2-3. Fastrise pulse displays.

Operating Instructions—Type S-4

the signal amplitude suddenly increases by approximately 500 mV. The displayed pulse of Fig. 2-3B is typical of the Type S-50 and Type S-4 combination.

In Fig. 2-3B the aberration occurring approximately 4.5 ns after the fastrise portion of the pulse is a result of a reflection at the input gate of the Type S-4. A portion of the fastrise part of the pulse traveling from the Type S-50, through the 2 ns length of coax and through the Type S-4 input connector to the input gate, is reflected back to the Type S-50. This round trip requires approximately 4.5 ns when the Type S-50 and Type S-4 are interconnected with a 2 ns section of coaxial line. Adding a second 2 ns section of line in series with the first would result in the reflection being displayed 4 ns (2 X 2 ns) later, or 8.5 ns after the fastrise portion of the pulse.

Determining Displayed Risetime

1. Set the fastrise portion of the displayed pulse to graticule center, as shown in Fig. 2-3B, using the Time Position control of the Type 3T2.

2. Change the Type 3S2 deflection factor to 100 mV/Div (Variable at CAL).

3. Vertically center the fastrise portion of the displayed pulse using the Type 3S2 Channel A Offset control.

4. Set the Type 3T2 Time Magnifier at X50 and readjust the triggering for minimum jitter using the Type 3T2 Sensitivity control.

5. Set the Type 3T2 Display Mag at X10 and carefully adjust the Time Position control for a display similar to that of Fig. 2-3C.

In order to accurately determine the displayed risetime the display should be photographed or stored (on a Storage Oscilloscope CRT) to permit careful analysis. To store the display, set the Type 3T2 Display Mode to Single Swp., the Type 554 upper and lower screen for storage, and push the Type 3T2 Single Sweep Start pushbutton.

The pulse risetime is found by determining the horizontal distance between the 10% and 90% amplitude points and multiplying this distance by the Time/Div setting of the sampling sweep unit. It is recommended that the 0% to 100% amplitude be adjusted to exactly 5 divisions using the Type 3S2 Variable control, and the display vertically centered using the Type 3S2 DC Offset control. This will position the 0% point 2.5 divisions below graticule center and the 100% point 2.5 divisions above graticule center. The 10% amplitude will then appear 2 divisions below graticule center and the 90% point 2 divisions above graticule center. More information on locating the 0% and the 100% points of the displayed waveform is given later in this section.

Gate Balance Adjustment

The Type S-4 Gate Balance may occasionally require re-adjustment. The location of the control is shown in Fig. 2-4. Channel A sampling head can be adjusted while on an extender cable or when inserted in the sampling unit. In order to adjust the Gate Balance of a Type S-4 located in the Channel B compartment of the sampling unit, it is necessary to remove the oscilloscope side panel and any sampling head plugged into the Channel A compartment.

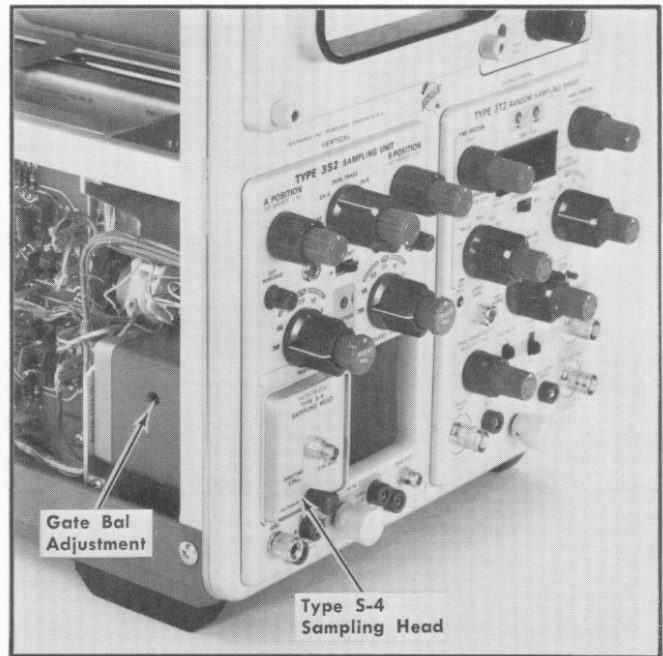

Fig. 2-4. Gate Balance location.

1. Connect a bench multimeter set for approximately 30 V full scale between ground and the Type 3S2 Channel A Offset jack.

2. Adjust the Type 3S2 DC Offset control until the multimeter reads 0 volts.

3. Increase the meter sensitivity and repeat the adjustment for greater accuracy.

4. Disconnect the semi-rigid cable from the Type S-50, leaving the other end of the cable connected to the Type S-4 input connector.

5. Turn the Type 3T2 Trigger Sensitivity control clockwise to free-run the trace.

NOTE

Operating the sampling head without the input connector terminated by a 50 Ω resistor or coaxial cable may cause a vertical shift of the zero signal baseline by a few millivolts. This is caused by the strobe kickout signal being reflected from the open input connector, and arriving back at the sampling gate while it is conducting. Because of this, terminate the input circuit when setting the display zero reference point. Also use a 15 cm airline, or a cable providing at least 500 ps of delay, between the Type S-4 input and any tunnel-diode generator or circuit that is sensitive to signals entering its output circuit.

6. Switch the Type 3S2 Units/Div control throughout its range, adjusting the Type S-4 Gate Balance control for a trace shift of not over one division as the Units/Div control is switched from one end to the other.

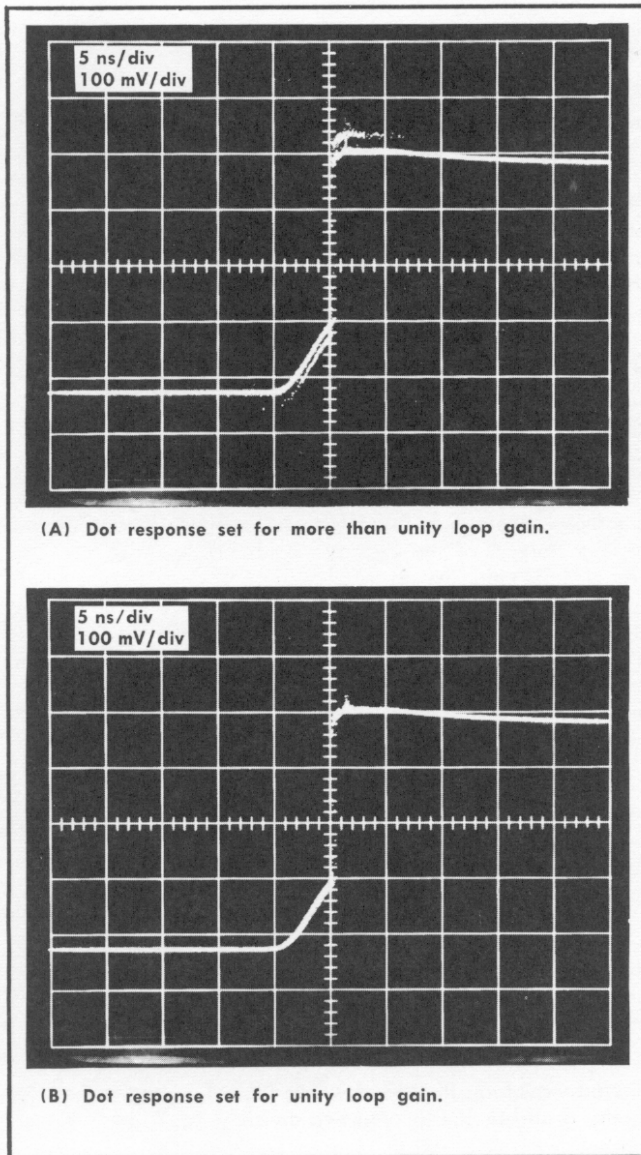

Fig. 2-5. Typical display changes with dot response adjustment when using random sampling operation.

OPERATING INFORMATION

Dot Response

Dot response of the sampling unit must be adjusted for unity loop gain to minimize waveform distortion and dot splattering. With unity loop gain the system will track the input signal closely.

An example of the appearance of a displayed waveform with the dot response adjusted for a gain greater than unity is shown in Fig. 2-5A. In Fig. 2-5A the Type 3T2 is set for random sampling (Before Trigger) and the Time Magnifier is set at 20. The output signal of the Type S-50 Pulse Generator is being applied to the Type S-4 input through a 2X attenuator. Fig 2-5B shows the effect on the displayed waveform of setting the dot response for a loop gain of unity.

Although proper adjustment of the dot response control is particularly necessary during random sampling, improper

adjustment of dot response (loop gain) will also result in a distorted waveform display during sequential sampling. Consult the Basic Sampling Principals and the Operating Instructions Section of your sampling unit instruction manual for further information about dot response and loop gain.

Smoothing

Setting the Normal-Smooth switch of your sampling unit to Smooth will result in a reduction of displayed noise. Since switching to Smooth reduces loop gain to approximately 0.3, transient response problems caused by low loop gain may show up. Smoothing should not be used when the Type 3T2 is used as a random sampler.

A loop gain of less than unity can be useful, if the resulting compromise is understood and the system is operated properly. Random noise in the display is reduced when loop gain is less than unity, since several consecutive samples are averaged. The averaging may also slow down the fastest risetime capability, depending upon the number of dots contained in the step transition. By increasing the number of dots (Samples/Sweep or Samples/Div) in a step transition, the display will follow the actual step transition more closely. If the number of samples (dots) in the step transition is reduced below 12 the true waveshape may not be displayed in Smooth.

Effect of Excessive Input Voltage

A maximum operating signal voltage of 1 volt (peak-to-peak) is specified for the Type S-4 in Section 1 of this manual. Signals having an amplitude of more than 1 volt (P-P) at the Type S-4 input may be distorted by the sampling head. Large signals must be reduced in amplitude to not more than 1 volt (P-P) at the Type S-4 input.

A 15 volt (P-P) signal can be reduced to a suitable amplitude at the Type S-4 input by inserting a series combination of 10X and 2X attenuators in the coaxial line delivering the signal. A series combination of 10X and 5X attenuators would also be satisfactory.

Displayed waveforms with several values of signal voltage applied to the Type S-4 input are shown in Fig. 2-6. Fig. 2-6A shows the displayed waveform with an input signal of 0.5 volt (P-P). In Fig. 2-6B the input signal has been increased to 0.9 volt. Fig. 2-6C shows the distorted display resulting from applying a signal of 1.1 volts (P-P) to the Type S-4 input.

See the discussion on Sine Wave Signal Measurements later in this section for information on signal amplitude affect upon display amplitude accuracy.

Risetime Measurements

Accurately determining risetime from an observed display requires that the position of the 10% and 90% points be accurately known and that the horizontal distance between these points be accurately measured. The timing accuracy of the sampling sweep unit must also be known. Switching the sampling sweep unit from one oscilloscope to another requires readjustment of the horizontal gain control on the sampling sweep front panel. See your sampling sweep unit

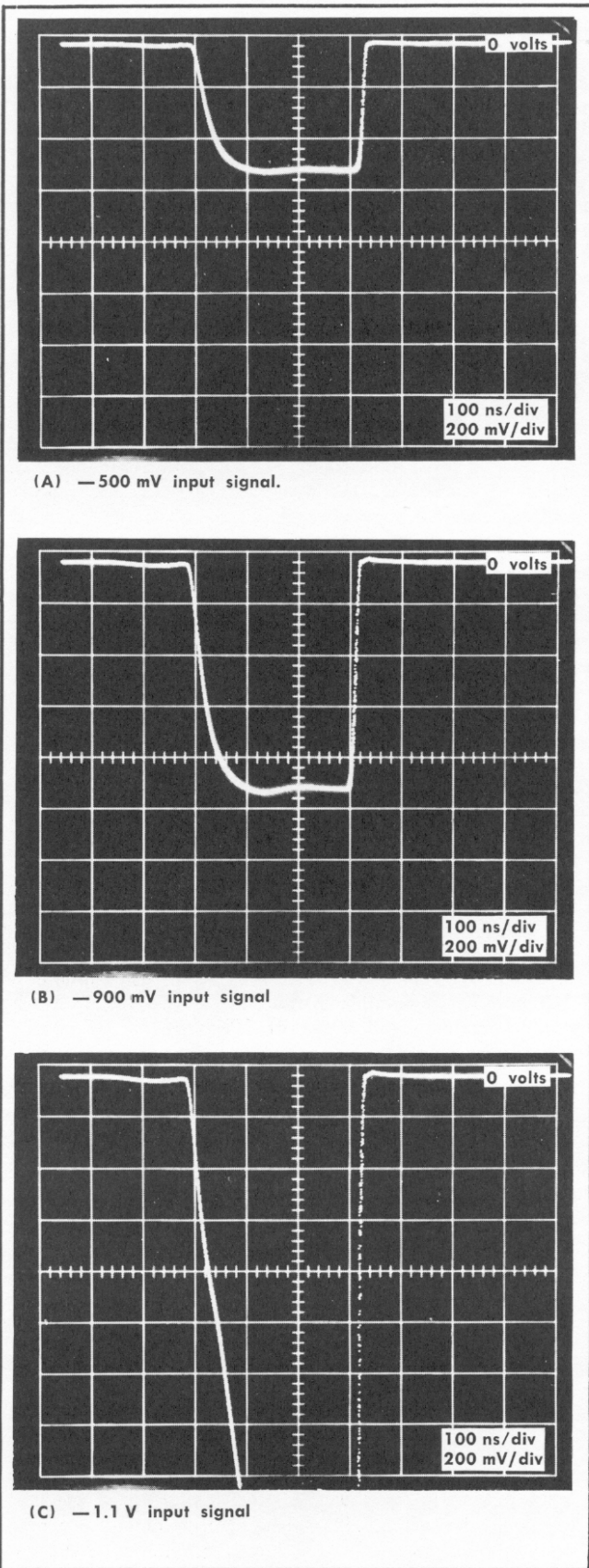

Fig. 2-6. Effect of input signal amplitude on display amplitude.

instruction manual for timing accuracy specifications and complete instructions for checking timing.

During First Time Operation earlier in this section a storage oscilloscope was used to display risetime. Ability to store a display is an advantage when determining risetime from the CRT display, especially when using a high dot density and a low signal repetition rate. An alternate method of determining risetime when a storage oscilloscope is not available and the display rate is slow is to photograph the display.

0% and 100% Levels with the Type S-4/S-50 Combination

When using the Type S-4/S-50 combination a special technique is used in locating the 0% and 100% amplitude levels of the displayed waveform. In Fig. 2-7 two reference position are shown. Reference point 1 is at the corner preceding the fastrise portion of the display. Reference point 2 is at the corner following the fastrise portion of the display. Both reference points are located where the rate of change of slope is maximum (where the radius of curvature is least). The 0% zone is centered 35 ps before the first reference point and the 100% zone is centered 35 ps after the second reference point. Each zone is 35 ps in width. The 0% and 100% levels are the average amplitude of the zones.

Follow the procedure below in determining the displayed risetime:

1. Locate reference point 1 and 0% zone.
2. Locate reference point 2 and the 100% zone.
3. Using the sampling unit DC Offset and Variable controls, set the 0% level 2.5 divisions below graticule center and the 100% level 2.5 divisions above graticule center. Remember the level is the average value within the zone.
4. Locate the 10% point on the fastrise portion of the displayed waveform (the point where the trace crosses the horizontal graticule line located two divisions below the graticule center).
5. Locate the 90% point on the fastrise portion of the displayed waveform (the point where the trace crosses the the horizontal graticule located two divisions above graticule center).
6. Multiply the horizontal separation, in divisions, between the 10% and 90% points by the Time/Div setting of the sampling sweep unit to determine the displayed risetime. The specified combined risetime of the Type S-4/S-50 combination is 35 ps.

Displayed Risetime and Actual Risetime

Differences in displayed and actual signal risetime will result unless the risetime of the sampling system is about four times faster than the risetime of the signal to be measured. As used in this discussion, the sampling system is considered to be made up of the sampling head and any coaxial line, connectors or accessories between the signal source (the Type S-50) and the sampling head. Displayed risetime is dependent upon the risetime of the sampling head, the risetime of the pulse generator, and the risetime of the cable and connecting components between the gener-

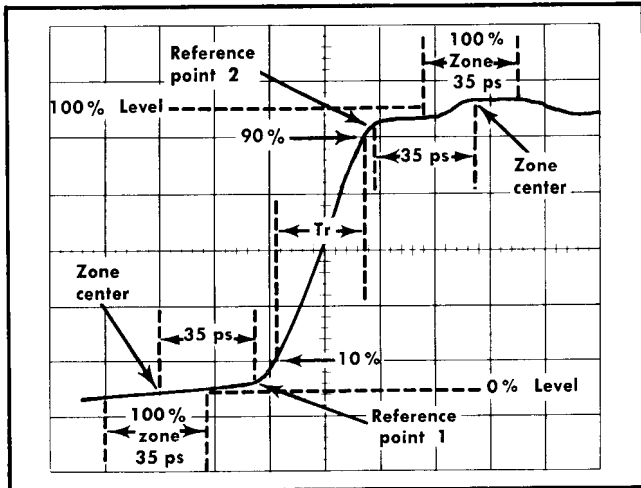

Fig. 2-7. Special S-4/S-50 system risetime measurement technique.

ator and sampling head. With signals as fast as about 100 ps arriving at the Type S-4 input, the displayed risetime will be very close to the actual signal risetime.

Since the risetime of the Type S-50 Pulse Generator output signal is much faster than 100 ps, the displayed risetime (with this pulse applied to the Type S-4 input) will not be the actual signal risetime.

The risetime of signals that are faster than 100 ps can still be determined using the Tektronix Type S-4 Sampling Head. However, the signal risetime is calculated using formula (2-2) below. Signal risetime calculated using formula (2-2) will provide a close approximation of the actual signal risetime.

The relationship between displayed risetime, signal risetime, signal path risetime, and sampling head risetime is shown by formula (2-1) below. What was referred to as system risetime has been broken down into T_r of signal path, and T_r of Type S-4 in formula (2-1). T_r of signal path includes the combined risetime of all coaxial cables, connectors, or accessories between the signal source and the Type S-4 input. If the signal path consists of a coaxial cable having a risetime of 8 ps and connectors and accessories having a risetime of 6 ps, the combined signal path risetime is

$$(8)^2 + (6)^2 \approx 100 \text{ ps.}$$

$$T_r \text{ (displayed)} \approx$$

$$\sqrt{(T_r \text{ signal})^2 + (T_r \text{ of sig. path})^2 + (T_r \text{ of Type S-4})^2} \quad (2-1)$$

For example, assuming an input signal having a risetime of 25 ps; connecting cable, accessories, and connectors having a risetime of 10 ps; and a sampling head with a risetime of 25 ps gives:

$$T_r \text{ (displayed)} \approx \sqrt{(25)^2 + (10)^2 + (25)^2}$$

$$T_r \text{ (displayed)} \approx \sqrt{625 + 100 + 625}$$

$$T_r \text{ (displayed)} \approx 37 \text{ ps}$$

Transposing formula 2-1 to permit calculation of signal risetime when the displayed risetime, signal path risetime, and sampling head risetime is known gives:

$$T_r \text{ (signal)} \approx$$

$$\sqrt{(T_r \text{ displayed})^2 - (T_r \text{ of Type S-4})^2 - (T_r \text{ of sig. path})^2} \quad (2-2)$$

Additional information concerning the effect of connecting cables on the displayed signal risetime may be found under Cable and Accessory Considerations later in this section.

Sine Wave Signal Measurements

The parameters of the Type S-4 are specified using pulse or time domain parameters and nomenclature. The frequency response characteristics of the unit, while not specified, are such that it may be used for relative sine wave measurements through its calculated upper 3 dB rolloff point of 14 GHz.

Because of the traveling wave gate used in the Type S-4, it is capable of handling very large signals as compared to other microwave samplers. Even so, the peak to peak signal amplitude should be held to as low a level as possible consistent with good signal to noise ratio when making checks in the 5 to 15 GHz region to avoid compression effects.

Cable and Accessory Considerations

When connecting a signal to the Type S-4 it is important that the signal coupling cable, connectors, attenuators and any other devices between the signal source and sampling head have the correct characteristic impedance, be capable of handling the signal frequency without causing excessive loss or distortion, and be of high quality. Care must be taken to firmly tighten all connectors, or unwanted reflections may result.

Accurate displays of signals containing very fast transitions or very high frequencies are possible only if the cables carrying the signal to the sampling head do not distort the signal. The Type S-4 input resistance is 50 Ω and requires the use of high quality, low loss, 50 Ω coaxial cables and attenuators between the signal source and the sampling head input connector. Using an adapter to change from 3 mm to a larger diameter coaxial cable will result in a loss of system bandwidth.

The Type S-4 sampling head is useful from DC up to at least 14 GHz. Standard and optional 3 mm accessories available from Tektronix are intended for use at frequencies to 18 GHz and are generally useful at frequencies to 25 GHz. Since any accessories in the path between the signal source and the Type S-4 input will increase the displayed signal risetime, use only high quality accessories of adequate high frequency capability. Accessories (3mm) supplied with the Type S-4, or available as optional equipment, include flexible and semi-rigid coaxial cable, attenuators, adapters to change from 3 mm to larger size coaxial cable, and a power divider. See your Tektronix Field Engineer or Representative for price and availability of optional accessories.

The physical and electrical characteristics of the cable determine the characteristic impedance, velocity of propagation and nature of signal losses.

Operating Instructions—Type S-4

It is important to use cables or airlines, in the signal-handling side of the system, that are as short as possible. Use of the optional 3 foot or 6 foot head extender cable permits locating the Type S-4 near the signal source and thereby keeps the input coaxial cable short and signal losses to a minimum. Signal losses along a coaxial line, due to skin effect or dielectric loss, result in a loss of high-frequency signal amplitude as the signal travels along the line. Dielectric loss along the coaxial line also results in an increase in the displayed risetime of fast step pulses. Dielectric and skin effect losses increase with signal frequency and the length of the coaxial cable. Fig. 3-8A shows the displayed waveform when the 25 ps output pulse of the Type S-50 is fed to the Type S-4 input through a semi-rigid 3 mm coaxial line available as an optional accessory. In Fig. 2-8B the 25 ps pulse is fed to the S-4 input through a 5 ns length of flexible 3 mm coaxial cable, Tektronix Part No. 015-1005-00. Fig. 2-8C shows the risetime of the displayed signal when the same 25 ps pulse is sent through a 5 ns length of good quality coaxial cable similar to Type RG-58/U. The importance of using a short length of the proper type coaxial between the signal source and the Type S-4 input is apparent from comparison of the waveforms of Fig. 2-8.

Another factor that can result in loss of signal in a coaxial cable is use of coaxial cable having a diameter that is large compared to the wavelength of the highest frequency components of the signal. The Type S-4 input connector is intended for use with Teflon dielectric coaxial cable having an outer conductor with an outside diameter of 0.141 inches.

Resistive losses in large diameter coaxial cable is less than in smaller diameter cable for frequencies below the critical value.

CAUTION

The two lines listed under part numbers 015-1015-00 and 015-1005-00 must be treated with care to obtain maximum life and least signal distortion. The semirigid line may have its shape changed just twice in its lifetime, providing the minimum bend radius is no less than 10 times its OD, or approximately 1½ inches. The flexible (2 ns delay) cable must not be given a bend radius less than 10 times its OD, or approximately 2¼ inches. (The same applies to a 5 ns signal delay flexible cable, Tektronix Part No. 015-1006-00.) The two flexible cables may have their outer conductor damaged by tighter bending. Few flexures assure longer life.

Use of Probes

A Tektronix P6034 or P6035 probe may be used with the Type S-4 Sampling Head. Connecting either of these probes to the Type S-4 input requires using a GR to 3 mm adapter. It should be kept in mind that the high frequency capability of the Type S-4 will be limited to that of the probe.

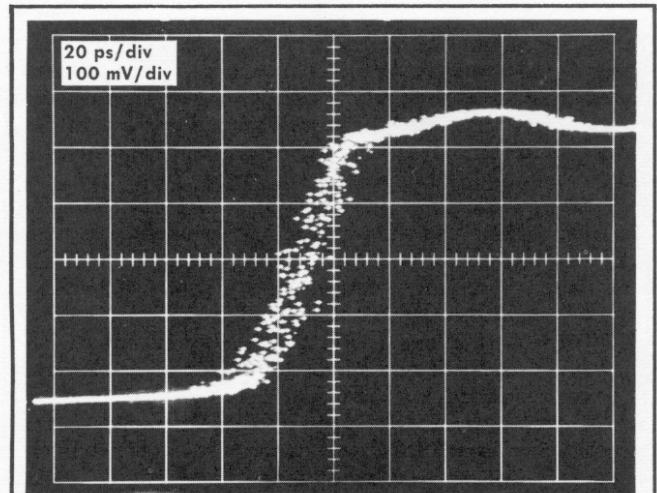

(A) 500 ps length of 3 mm semi-rigid coaxial cable.

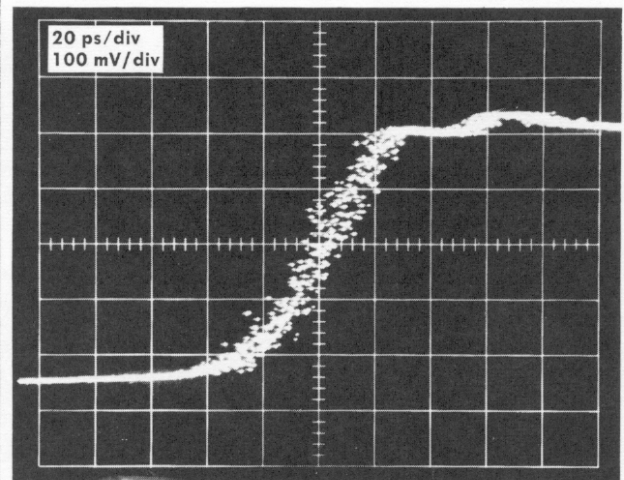

(B) 5 ns length of 3 mm flexible cable.

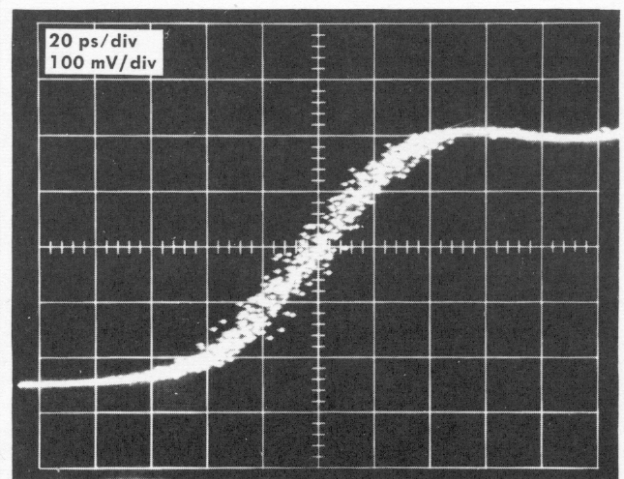

(C) 5 ns length of cable similar to RG 58/U.

Fig. 2-8. Effect of cable length, diameter, and quality on displayed risetime.

SECTION 3

CIRCUIT DESCRIPTION

Change information, if any, affecting this section will be found at the rear of the manual.

General

This section of the manual contains a block diagram description of the Type S-4 Sampling Head followed by a detailed circuit description. Read the section on Basic Tektronix Sampling Principles, located in the associated sampling unit manual, if the function of a particular Type S-4 circuit is not clear. Both the block and schematic diagrams are located at the rear of this manual.

The Type S-4 is the signal input section of a sampling system, and determines the vertical channel input characteristics. The special traveling-wave gate at the input differs from the sampling bridge described in the Basic Sampling Principles section of the sampling unit manual.

BLOCK DIAGRAM

Both the Block Diagram and the circuit schematic show the Type S-4 circuits outlined by dashes, indicating the individual circuit boards within the unit. One circuit board is devoted to the generation of the sampling gate strobe pulses, one to the sampling gate, one to the blow-by and trigger pickoff amplifier and one to the preamplifier.

Strobe Generator

The Strobe Generator develops heavy-current (several mA), short-duration, push-pull pulses that drive the Sampling Gate into balanced conduction. Output occurs at the time of each sample when a command pulse arrives from the Strobe Driver circuit of the associated sampling unit. The pulse lasts for a period of about 125 ps, turning on the Sampling Gate diodes. At the end of the pulse, the diodes turn off very quickly, retaining a portion of the input signal. Strobe pulse duration and fall time are fixed by the Snap-Off diode D61, and the two clipping lines. The Strobe Generator parts layout and circuit board construction are carefully controlled during manufacture to ensure proper strobe pulses being sent to the Sampling Gate.

Sampling Gate

The Sampling Gate (called the Sampling Bridge in other Tektronix sampling circuitry) connects the input signal to the Preamplifier only during the short time when each sample is taken. The six diodes, D2A through D2F, form what is technically termed a traveling wave gate. It is the way the end of the Strobe Drive pulse travels through the gate that determines the step response of the sampler. In other Tektronix sampling bridges, the step response risetime is controlled by the strobe pulse duration. In the Type S-4, the step response risetime is controlled instead by the length of time

it takes the strobe pulse end to travel through part of the Sampling Gate.

At the end of each Strobe pulse, part of the input signal is stored temporarily between Sampling Gate diodes and is then fed to the Preamplifier input at a rate much slower than the step response risetime. It is only the special traveling wave gate that has its electrical environment controlled for minimum reflections of fast pulse signals. All circuit parts that pass the sampled error signal (see the sampling unit manual section on Basic Sampling Principles for definition of error signal) to the Preamplifier handle only moderate rate-of-rise signals. A special 10 X (20 db) 50 Ω attenuator helps serve as a high-quality, high-frequency termination to the input connector and the 50 Ω environment of the traveling wave gate.

Part of the input signal is continuously passed to the Trigger Amplifier Board and the Blow-by compensating and Trigger Pickoff circuit. The signal passes through the 10 X attenuator directly to the Trigger Amplifier Board and is terminated in 50 ohms there.

Gate Bias

Reverse bias is applied to the Sampling Gate diodes by the Gate Bias circuit. The average voltage of the gate bias is controlled by the Gate Balance circuit and the associated sampling unit DC Offset and Feedback signals. The Sampling Gate output is DC coupled to the Preamplifier input through a portion of the Gate Bias circuit.

Blow-by and Trigger Pickoff

The primary function of the Blow-by and Trigger Pickoff circuit is to cancel capacitively-coupled unwanted signals that normally bypass the Sampling Gate. These unwanted signals are called "blow-by" signals.

The Type S-4 special traveling wave Sampling Gate contains two blow-by reducing diodes that minimize the capacitively-coupled unwanted signals. The special Sampling Gate construction and the blow-by circuit cancel essentially all of the unwanted signals that would otherwise distort the oscilloscope sampling display.

The Blow-by and Trigger Pickoff circuit receives an attenuated portion of the input signal and terminates the 10 X attenuator that is located between the Sampling Gate and the Trigger Amplifier Board. The circuit amplifies and inverts the signal and applies it, as a blow-by correction signal, through a small capacitor to the output side of the Sampling Gate blow-by limiting diodes. Magnitude of the blow-by correction signal is adjusted during calibration by the Transient Response control.

Circuit Description—Type S-4

The trigger pickoff function of the Blow-by and Trigger circuit provides an in-phase signal source for internally triggering the sampling sweep unit. Not all channels of all sampling units (in which the S-4 operates) couple the trigger pickoff signal to the sampling sweep unit. If the signal is not used, the sampling unit terminates the output in 50 Ω , allowing the circuit to remain functional for blow-by correction.

Preamplifier

The Preamplifier circuit both amplifies and time-stretches the signal it receives from the Sampling Gate. The signal received is a portion of the difference between the Feedback combined with the DC Offset voltage and the input signal. This "error signal" is amplified and AC coupled to the Post Amplifier in the sampling unit. The Preamplifier gain is adjustable to aid in setting the overall sampling head and sampling unit "loop" gain to unity for proper dot response.

CIRCUIT DESCRIPTION

Refer to the main schematic diagram during the following descriptions. The Type S-4 Sampling Head uses the power supplies of the indicator oscilloscope and associated sampling unit. Interconnections to the sampling unit circuits are by two connectors at the sampling head rear. The following description includes references to circuits in the sampling unit and sampling sweep unit, all units forming one sampling system. Reference to diagrams and circuit descriptions in the instruction manuals for the other sampling units will help in gaining a full understanding of the circuit relationships.

Strobe Generator

The Strobe Generator circuits are all located on the (right side) Strobe circuit board. The generator contains two basic circuits, an Avalanche circuit that delivers fast push-pull pulses, and the Snap-off diode and clipping lines circuit. Both circuits work together to produce the push-pull strobe pulses that drive the special traveling-wave Sampling Gate through two equal transmission lines. Both sets of circuitry are physically arranged over separate ground planes that are identified on the main schematic diagram. The two ground planes are connected together by R52 and R54, to damp out ringing between the two circuit areas at sample time.

The Avalanche Circuit converts the Strobe Drive pulses from the sampling unit to very fast push-pull pulses that drive the Snap-off diode to non-conduction.

The Strobe Drive pulse is transformer-coupled by T75 to the base and emitter of Avalanche transistor Q69. Two outputs are AC-coupled from Q69, one from the collector and the other from the emitter. The Avalanche Volts control adjusts the collector voltage of avalanche transistor Q69. The typical quiescent voltage at Q69 collector is about +15 volts. This voltage sets the amplitude of the signals that drive the Snap-off diode circuit and assures the normal avalanche action of Q69 when driven by the Strobe Drive signal. Before Avalanche conduction, there is a potential of about 60 volts between Q69 collector and emitter.

The negative Strobe Drive pulse is transformed into a hard forward bias signal to Q69. Normal avalanche action follows with the collector going negative and the emitter going positive. This fast-rise, push-pull signal is capacitively coupled to the Snap-off circuit.

The Snap-off Circuit operates as a current switching circuit to apply some of the push-pull Avalanche current signal at snap-off time to the Sampling Gate. The circuit consists of a Snap-off Current control R57, Q55, Snap-off diode D61, two clipping lines and associated components. Between drive pulses from the Avalanche circuit, the Snap-off diode D61 is forward-biased by the current in Q55. The current value is set by the Snap-off Current control R57. The current in D61 is typically 20 mA. This forward current assures that D61 has many carriers within its junction region.

The push-pull signals from the Avalanche circuit cause D61 junction carriers to reverse direction as a heavy reverse current. This heavy reverse current stops suddenly as all the carriers clean out of the junction. As the reverse current "snaps" to a stop, the push-pull avalanche signals are suddenly coupled into the clipping lines by C52 and C54 and toward the Sampling Gate by R51-C51 and R53-C53. The fast-rise step which appears at each clipping line input is propagated down the line. About 50 ps later the steps reach the short circuited ends of each clipping line. The step is then reflected, equal in amplitude and opposite in polarity, back to the input end of each clipping line. This cancels the signals moving toward the Sampling Gate. This action results in a positive Strobe pulse being delivered to P53, and a negative Strobe pulse being delivered to P51.

The clipping lines have a surge impedance of approximately 10 Ω with a very good short circuit at the shorted ends. The high quality of the short, and the line low impedance causes the reflected signal to stop the Strobe pulses very rapidly. Such rapid ending of the Strobe pulse and the characteristics of the traveling wave Sampling Gate causes each sampling diode to turn off in approximately 10 ps. The fast diode turn-off is discussed below in the Sampling Gate description.

Ringing of the Snap-off diode and the clipping lines is very rapidly. Such rapid ending of the Strobe pulse and the lines ends. Ringing is also limited to some degree by the two equal resistors R60 and R62 that are in DC series connection with the Snap-off diode D61. The primary function of R60-R62, however, is to provide a DC path for D61 forward conduction while at the same time allowing the Avalanche signals to pass on into the clipping lines and Sampling Gate. As the Avalanche pulses end and as both the Avalanche and Snap-off circuits recover for another sample, R60-R62 re-establish the correct quiescent charges on C63 and C64. C59 assures a very low impedance AC path for the ground side of R60 so that R60 and R62 will both have the same affect upon the circuit.

Another technique for minimizing Strobe ringing is that of R51 and R53 being in series with the output lines to the Sampling Gate. The output connectors that connect the Strobe board to the Sampler board have a 50 Ω characteristic impedance. R51 and R53 raise the Clipping lines 10 Ω impedance drive to 50 Ω to properly match the connections. Thus, at the end of the Strobe pulse, reflections back from the Sampling Gate are reverse terminated. These resistors and the resistors discussed in the preceding paragraph all

assure that there is no possibility of double strobing of the Sampling Gate due to ringing of the Strobe Generator circuits.

Two separate ground planes are identified on the main schematic diagram between the Avalanche and Snap-off circuits. Two resistors connect the two ground plane ends together to damp any natural ringing when the case is off. Ringing can occur without R52 and R54 because the two ground planes are connected together at the instrument front and rear through the Sampler board. Rake-type ground symbols (USA Standard ASA Y 32.2, 1967) on the diagram identify chassis ground return circuits connected to the front panel or case. Triangle-type ground symbols are used throughout the Sampling Gate area, Strobe Generator and Trigger board areas to indicate these circuits all share a common grounding system with the signal input connector, J1. Component layout is organized so the strobe signal ground currents balance to zero at the center of the Sampling Gate, and thus do not contribute unwanted currents to the input signal. Q69 circuit is capacitively isolated from both ground planes as much as possible, with its primary signal output path being through C63-C64 and C52-C54. There is a small third terminal capacitance to ground between the two windings of T75, but it is not large enough to disturb the balanced drive from Q69 to D61.

Sampling Gate and Gate Bias Circuits

The Sampling Gate consists of six series diodes, D2 A through F, and four resistors all mounted on a ceramic substrate inside the input circuit holder. See Fig. 3-1 during the following discussion.

The signal that arrives at J1 travels right on through the Sampling Gate area to a 3 mm 50 Ω 10X (20 db) attenuator. Output of the attenuator feeds the Trigger and Blow-by Compensation circuit where it is terminated in 50 Ω . When not being strobed, D2C and D2D present a very small value of capacitance to the input signal. When the diodes conduct due to Strobe current, the input line is coupled to the traveling wave gate.

Gate Biasing

Quiescent condition of the Sampling Gate diodes is controlled by the Gate Bias circuit. D2A, D2B, D2E and D2F are each reverse biased about 0.5 volts by D20, D23, D25 and D28. D2C and D2D are reverse biased about 1.2 volts each, a total of about 2.45 V is developed across the parallel combination of R24-C25 of the Gate Bias circuit. The Gate Bias circuit receives its current from the two 50-V supplies and R30-R31-R32-R33 and R34 of the Gate Balance control circuit. The diodes of the Gate Bias circuit are used as 0.5-volt Zener diodes. R2A-R2F with C24 and R2B-R2E with C25 isolate the traveling wave gate segments from the Preamp and Bias circuits R21-R26 conduct DC bias potentials to the gate but allow a sampled error signal to drive C24 and the Preamplifier input.

Except for the very short strobed conduction time (about 125 ps), the Sampling Gate diodes do not conduct. A portion of the input signal is coupled through stray capaci-

ties to the Preamplifier input, and disturbs the normal sampling display. This effect is known as "blow-by".

Blow-by Correction

The basic risetime of the traveling wave Sampling Gate is 25 ps. In this extremely short interval of time, only a very small amount of charge can be collected in one sample. What small charge is collected, is called the error signal and is amplified by the Preamplifier and the sampling unit circuits. The Preamplifier has a shaped frequency response best suited to amplifying each samples small charge and delivering a proper error signal to the sampling unit.

It is impossible to build a sampling gate without a path for blow-by displacement currents that cause the Preamplifier to respond to a part of some input signals and thus distort the display. The Type S-4 Preamplifier responds to signals in the 0.5 to 3 MHz bandpass region. Signals much higher or lower in frequency are not amplified. Those blow-by signals in the Preamplifier bandpass region that do get through the Sampling Gate are virtually eliminated by the Blow-By correction amplifier Q10. The traveling wave gate is constructed by double differentiate signals in the Pre-amplifier response domain while not affecting the small sampled charge quantities obtained during each sample interval.

Blow-by rejection in the Sampling Gate is assured by the double differentiation networks that have very fast RC times. They are located between the signal input and the Preamplifier. The first differentiation network is formed by reverse biased diodes D2C and D2D and their respective resistors to ground (see Fig. 3-1), R2B and R2E. The second network is formed by diodes and resistors D2B, D2E and R21, R26, respectively. All the Sampling Gate diodes are normally non-conducting and are therefore very small capacitors. The differentiating networks eliminate all but about 5% of the possible blow-by effects. The Blow-By correction amplifier feeds an inverted replica of the input signal into the Sampling Gate output, a small quantity of charge passes through C19 to cancel most of the remaining blow-by signal.

Traveling Wave Sampling Gate

Push-pull strobe pulses from the Strobe Generator cause the six Sampling Gate diodes to conduct for about 125 ps. While the diodes are conducting, the signal at the input connector propagates down the diode transmission paths as well as toward the 10X attenuator, R3. As the fast falling strobe pulse end begins to propagate into the diode transmission paths, the diodes are quickly switched off (into reverse bias), one set after another. First, diodes D2A and D2F turn off, then D2B and D2E, and finally D2C and D2D. Turn off time of the diode sets is controlled by the mechanical spacing and thereby the propagation time between sets. The Sampling Gate risetime is determined by these propagation times, and is thus not heavily influenced by the strobe pulse amplitude or duration. The sampling process is thus one of trapping signal charge between sets of diodes, in particular, between set D2A-D2F and the set D2B and D2E. The risetime is very close to the double transit time between sets.

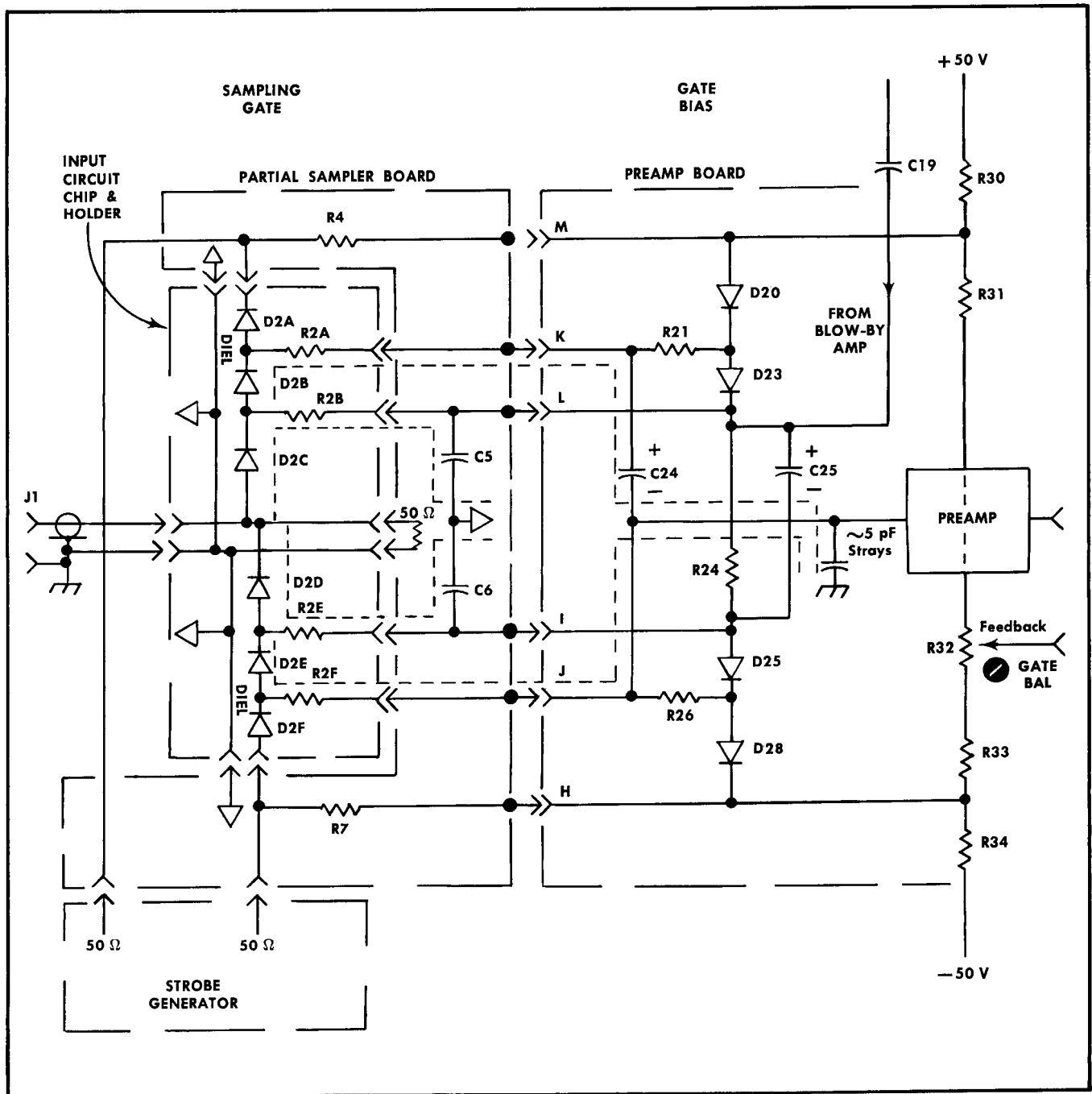

Fig. 3-1. Traveling wave Sampling Gate and Gate Bias circuit components, with input signal blow-by differentiating paths shown by dotted lines.

Once the signal charge trapping process has taken place (at the strobe pulse end), the Preamplifier begins to receive the trapped charge by conduction through resistors R2A and R2F (See Fig. 3-2). The Preamplifier input capacitance is much larger than the capacitance of the transmission line segments between the diode sets, causing practically all of the trapped charge to finally transfer to the Preamplifier input. The transfer time constant is approximately 10 nano-seconds.

Because of the carefully adjusted balance of the plus and

minus strobe signals (set by the physical position of R51 and R53 in the Strobe Generator), the Preamplifier receives only the trapped signal charge and nothing from the Strobe Generator.

Preamplifier

The Preamplifier circuit amplifies and time-stretches the error signal pulse from the Sampling Gate, and AC couples it to the Post Amplifier in the associated plug-in unit.

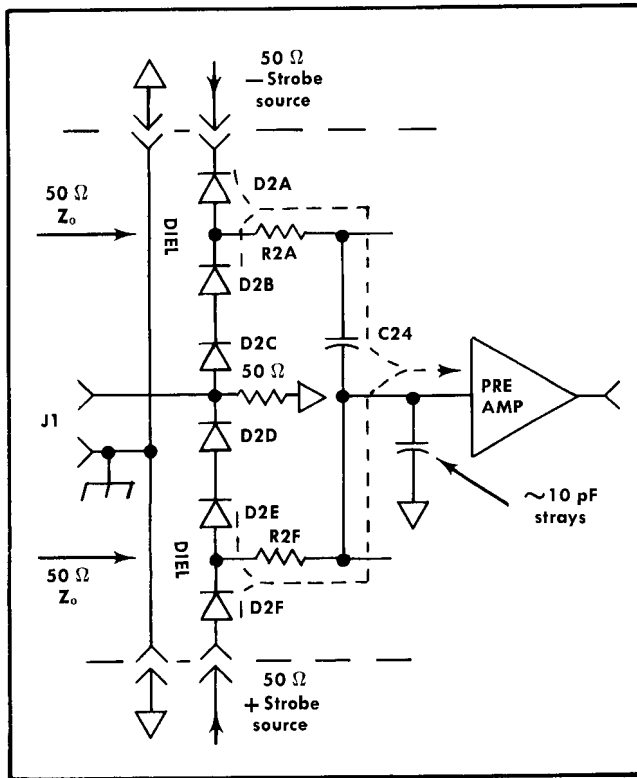

Fig. 3-2. Error-signal source and path to Preamp shown by dotted lines.

Input transistor Q36 operates as a very high input impedance, high-gain inverting amplifier. Temperature compensation for Q36 is accomplished by thermistor R33 in parallel with R39. A total of 4.4 mA channel current passes from the +50 volt supply through R36, Q36, the parallel combination of R33-R39 and R40 to the -50 volt supply. C39 assures that Q36 AC gain is high, while its DC gain is less than 1.

Q43 and Q46 are connected as an operational amplifier with a very low output impedance at Q46 emitter. The output is coupled by C50 to the 90 Ω input resistance Post Amplifier in the sampling unit. D41 protects Q43 base from high negative voltage if Q46 is removed from its socket.

Current in R40 with DC negative feedback by R48 sets the output DC voltage level of the amplifier at about 7.3 volts. Negative AC feedback from the emitter of Q46 through C49 and Gain control R49 to Q43 base controls the AC gain of the Preamplifier. Gain control R49 allows the AC feedback to be adjusted, thereby adjusting the gain. The AC gain is adjusted during calibration so that the sampling head has the correct amplitude output signal to the sampling unit Post Amplifier.

The Type S-4 sampling efficiency is less than 2%. (See the sampling unit instruction manual Basic Sampling Principles for sampling efficiency definition.) With a low sampling efficiency, the Preamplifier positive and negative signal out-

put impedance must both be low. Q46 assures a low output impedance for positive-going output pulses, and D43 assures a low output impedance for negative-going output pulses. D43 conducts only for large negative output signals that fall at a rate faster than Q46 emitter can follow. Q46 emitter remains a low output impedance for small negative output signals.

Components not already mentioned above include: C47 and R46 that both prevent parasitic oscillations of Q46, and C45-C46 that decouple the +15-volt supply for both low and high frequency current pulses of Q46.

Blow-by and Trigger Pickoff

The Blow-by and Trigger Pickoff circuits consist of Q10, Q14 and associated components connected as a common-emitter paraphase amplifier. The primary purpose of the circuit is to cancel unwanted high frequency capacitively-coupled signals that bypass the Sampling Gate. The secondary purpose is to provide a trigger pickoff signal to the sampling unit for internal triggering of the sampling sweep unit.

Input signal to the Blow-by and Trigger Pickoff circuit is a portion of the Type S-4 input signal. The signal is fed to the base of Q10 through R3. R10 terminates the 50 Ω impedance of the input and assures no reflections back into the input circuit. The output from Q10 collector feeds an AC coupled signal to the output side of the Sampling Gate, cancelling the blow-by signal. The output from Q14 collector feeds a DC coupled trigger pickoff signal to the sampling unit for use by the sampling sweep unit.

Feedback Limiting

The Preamplifier input is the input terminal of an integrating pulse amplifier that includes the sampling unit Post Amplifier, AC Amplifier, Memory Gate and Memory Amplifier. Feedback from the Memory Amplifier output is DC coupled to the Type S-4 Preamplifier input through the sampling unit Feedback Attenuator and the Type S-4 Gate Bal control.

As a sample is taken, the error signal is amplified and converted to a DC signal for both the CRT and the feedback that arrives through pins 2 and B of the sampler board. The maximum feedback is limited to approximately ± 1.2 volts by two resistive dividers and D80 and D82. The limiting is to prevent excessive feedback voltage from reaching the Sampling Gate when the sampling unit Units/Div switch is changed between positions. In certain conditions of operation, the excessive feedback can cause the Sampling Gate to go into a mode of conduction that holds the CRT beam off screen. By limiting the feedback amplitude, overdriven displays will leave the CRT screen but will return just as soon as the overdrive is removed. Without the limiting, an overdrive signal could cause the display to disappear.

SECTION 4

MAINTENANCE

Change information, if any, affecting this section will be found at the rear of the manual.

Introduction

This section is a maintenance guide for the Type S-4 Sampling Head. Some circuit testing and repair suggestions are included. See the Circuit Description for additional circuit details if a problem exists that is not covered here. Parts ordering, disassembly and reassembly information is also included.

To remove the Type S-4 Sampling Head from its case, loosen the four retaining screws on the back. Then slide the back off and remove the case by sliding it to the rear. Directions for replacing the case will be found at the end of this section.

Parts Removal and Replacement

All parts used in the Type S-4 can be purchased directly through your Tektronix Field Office or Representative, although standard electronic items may be obtained locally. Replacements for the special parts used in the Type S-4 should be ordered from Tektronix since these parts are either manufactured or selected by Tektronix to satisfy a particular requirement. Before purchasing or ordering, consult the Electrical or Mechanical Parts List to determine the value, tolerance and ratings required.

NOTE

When selecting the replacement parts, it is important to remember that the physical size and shape of a component may affect its performance at high frequencies. Parts orientation and lead dress should duplicate those of the original part since many of the components are mounted in a particular way to reduce or control stray capacitance and inductance. After repair, the sampling head may require calibration.

Transistor Replacement. Cut the leads of a replacement transistor to the same length as the transistor removed and bend the leads as necessary. The lead configurations of the transistors used in the Type S-4 are shown in Fig. 4-1. Two transistors on the Trigger Amp circuit board (Q10 and Q14) have soldered leads. Field-effect transistor Q36 mounting has an arrow at the tab position.

Leadless Capacitors. There are leadless ceramic capacitors soldered directly to the circuit board. Care must be taken when replacing these capacitors as they crack easily. The type of solder used must be electronic grade 60/40 or 62/38 solder with good cold-flow characteristics.

Solder the leadless capacitor into place by positioning the part and applying heat to the adjacent plated area.

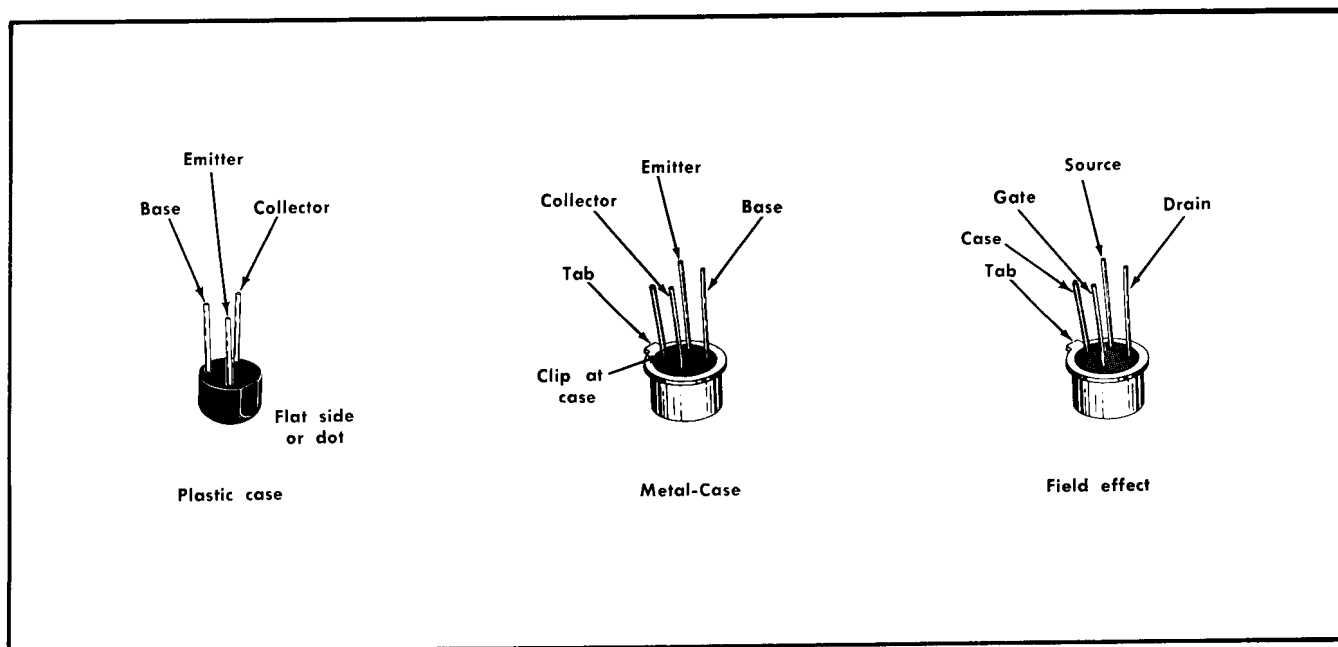

Fig. 4-1. Lead configuration of transistors in the Type S-4.

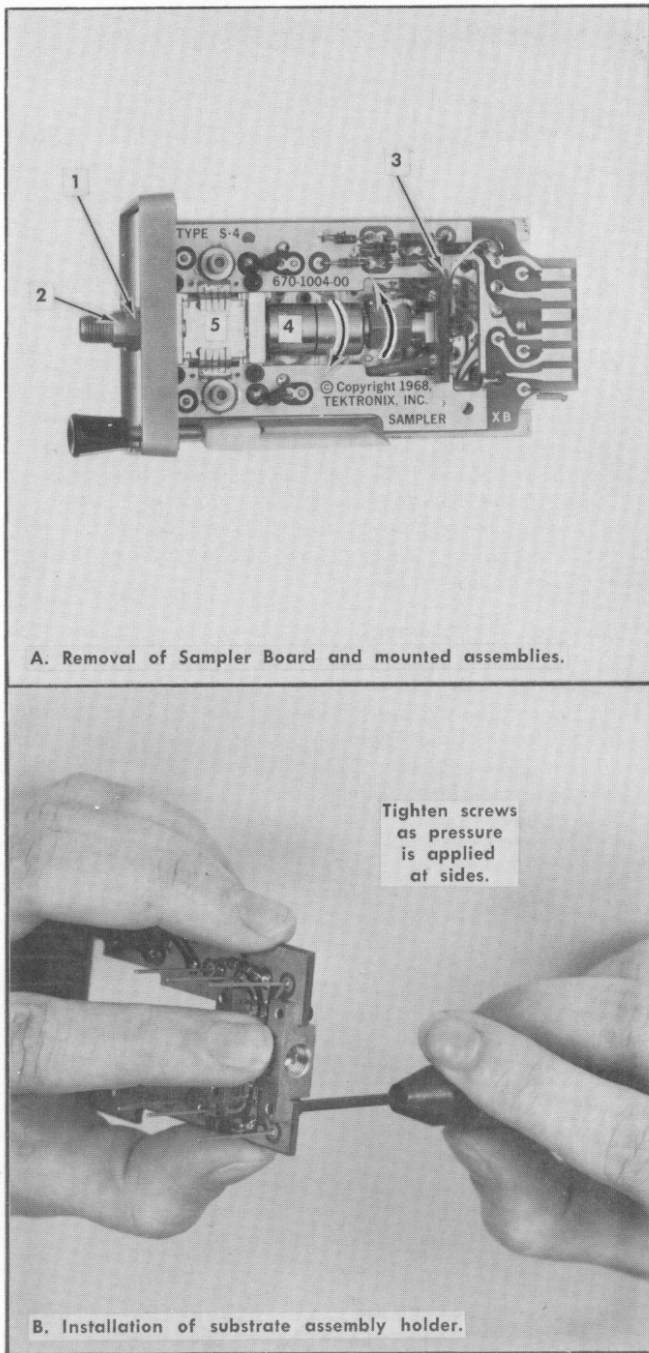

Fig. 4-2. Sampler Board removal and reassembly.

Solder leads to the leadless capacitor by applying heat to the leads. Excess solder on either side of the capacitor can lead to a shorted circuit.

Removal and Replacement of Snap-off Diodes. The Snap-off diode is mounted in small metal clips, as shown on the circuit board illustration. The diode is best removed or replaced with a pair of shaped plastic tweezers, such as Tektronix Part No. 006-0765-00, or its equivalent.

Circuit Board Replacement. If a circuit board is damaged and cannot be repaired, the entire assembly including

all soldered-on components should be replaced. The part number given in the Mechanical Parts List is for the completely wired board.

The Strobe Board and the Preamp Board are removed by gently pulling outward from the Sampler Board. The Preamp Board holds the pretrigger output connector, P17, and a coaxial cable from the Trigger Amp Board soldered to the junction of R17 and R18. For replacement, align the connectors and pin contacts and ease the boards into position. Pin connectors should not protrude beyond the clamps.

Remove the Sampler Board as in Fig. 4-2 and as follows:

1. Loosen, but do not remove, the threaded nut on the Input connector with a $\frac{5}{16}$ inch wrench.
2. Loosen the Input connector with a $\frac{7}{32}$ inch wrench. Remove the Input connector with the fingers.
3. Unsolder the -12.2 volt lead to the Trigger Amp Board.
4. Loosen, but do not remove, the $\frac{5}{16}$ nut holding the Trigger Amp Board. The Trigger Amp Board is wired to the Sampler Board and to the Preamp Board.
5. Remove the attenuator by unscrewing it from the substrate assembly (right hand thread) and then slide both the attenuator and the Trigger Amp Board to the rear.
6. Remove the substrate assembly, bracing it with a finger as in Fig. 4-2B, by removing the hexagonal screws with a $\frac{3}{64}$ inch Allen wrench. Lift the substrate assembly away from the Sampler Board.

NOTE

Do not touch the gold plated areas on the substrate which are visible at the sides, due to the possibility of contamination from natural body oils.

Replacement of the mounted assemblies and the Sampler Board follows:

1. Place the substrate assembly on the Sampler Board between the pins, which prevent forward or backward movement, and brace the substrate assembly as the hexagonal screws are screwed in approximately half a turn. Apply pressure at the Sampler Board sides, see Fig.4-2B, and tighten the front screws. The substrate should orient itself for best electrical contact. Then tighten the rear screws and release the pressure.
2. Install the attenuator and Trigger Amp Board.
3. Tighten the coupling nut. Solder the -12.2 volt lead to the board. The Preamp Board may be placed into position at this time.
4. Place the front panel so the Input connector will align with the substrate assembly. Make sure the plastic locking pawl is positioned with the flat surface facing downward. Finger tighten the connector. Tighten the Input connector with a $\frac{7}{32}$ inch wrench to 10 in-lbs, estimated, if no torque wrench is available. Tighten the locking nut with a $\frac{5}{16}$ inch wrench to 15 in-lbs.

Replacement of the Sampling Gate substrate assembly or of the Strobe Board may cause a system unbalance, resulting in strobe kickout from the Input connector. This con-

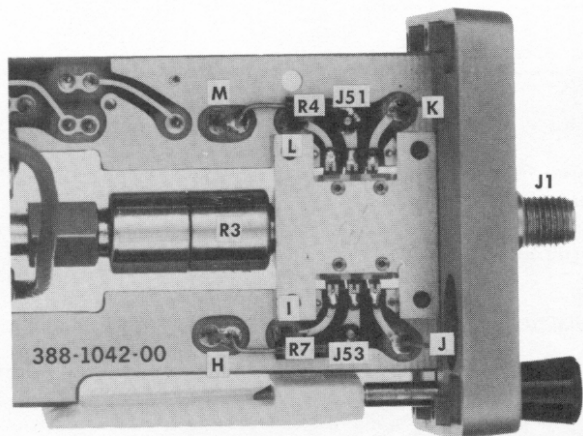
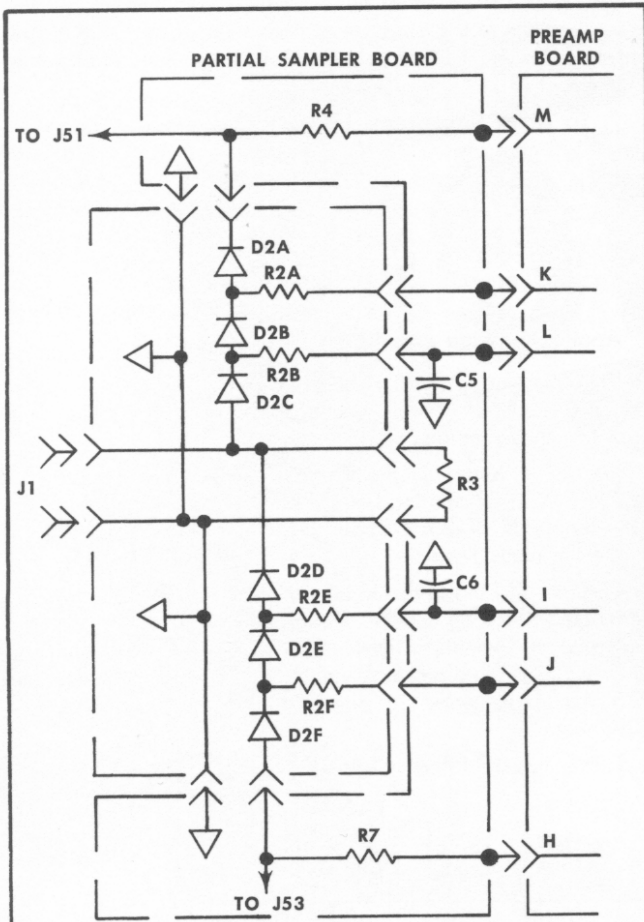

Fig. 4-3. Sampling Gate circuit and test points for checking the diodes.

dition is corrected by resoldering R51 or R53 (possibly both) to a different point on the clipping lines. See step 13 in the Performance Check/Calibration Procedure.

Checking Sampling Gate Diodes

A dynamic check of the condition of the forward characteristics of the sampling gate diodes can be quickly made by following the procedure outlined in Section 5, step 13f, of this manual. In this check, the diodes are checked for both + and - strobe pulse conduction. If either the + or the - strobe pulse is not found in this dynamic check, then further static checks can be performed on the gate, as outlined below. If both strobe polarities are observed, the other circuits of the sampling head should be checked for problems, leaving the sampling gate till last.

The Sampling Gate diodes can be specially checked by the use of a transistor characteristic curve tracer, such as the Tektronix Type 575. **DO NOT USE AN OHMMETER TO CHECK THE SAMPLING GATE DIODES.**

Once it has been decided to check the Sampling Gate diodes, refer to Fig. 4-3 for both the Sampling Gate circuit and test points used in the procedure listed below. The procedure outlines a method of checking forward conduction in groups of three, and reverse leakage on an individual basis.

1. Remove the sampling head case and the Preamplifier board. Leave the attenuator and Strobe Board in place.

2. Refer to Fig. 4-3 for testpoints that must be used for checking D2A, D2B and D2C in one group or D2D, D2E and D2F in a second group. For the first group, the curve tracer positive lead is to be attached to ground and for the second group the positive lead is to be attached to J53. Attach the negative lead of the first group to J51. When checking the second group ground the negative lead. These polarity connections test each group of three diodes for their forward conduction in the curve tracer first quadrant as shown in Fig. 4-4.

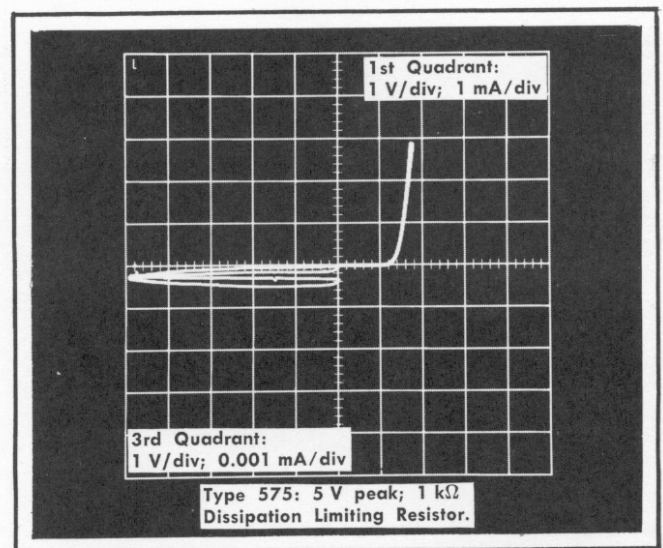

Fig. 4-4. Type 575 Characteristic curves of forward and reverse voltage conduction of D2A, D2B and D2C. Do not use more than 5 volts peak.

Maintenance—Type S-4

3. Set the Type 575 controls:

Vertical Current	
Collector mA	1 mA/Div
Horizontal Volts/Div	
Collector Volts	1
Peak Volts Range	20
Polarity	+
Peak Volts	For no-load 5 divisions horizontal trace display.
Dissipation Limiting Resistor	100 Ω
Base Step Generator Controls	Optional, not used.
Sloping Panel Controls	
Grounding Sw	Emitter Grounded
Selector Sw	A or B, whichever side has had clip leads attached for the test.
Both Position Controls	Dot at Graticule center.

4. Attach two leads to terminals of the Type 575 sloping front panel. Small clip leads or meter leads with banana tips on one end and prongs on the other end will do. Attach one lead to an E binding post and the other to the C binding post above the E post. Place the selector switch so it points toward the side where the test leads are connected.

5. Connect the E lead to the Sampling Gate terminal J51 and the C lead to ground. The Type 575 display should now be like the first quadrant display of Fig. 4-4. If the display shows slightly more than 1.2 volts flat display and then a rising portion like Fig. 4-4, the three diodes D2A, D2B and D2C are operating correctly in the forward direction. Check the other three diodes forward conduction before measuring either set reverse leakage.

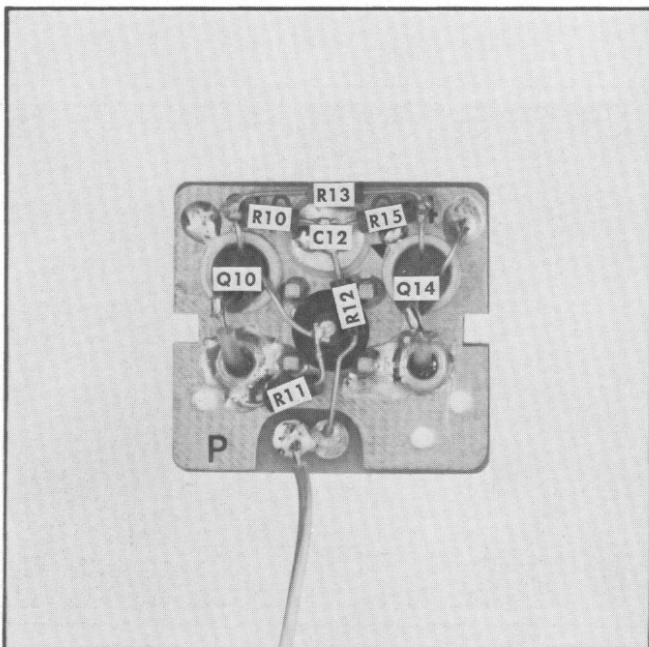

Fig. 4-5. Trigger Amp circuit board.

6. Move the test leads so the E lead is touching the sampling head ground and the C lead is touching J53. The display should be the same as that in the first quadrant of Fig. 4-4.

7. To check the reverse leakage of a diode, change the Type 575 controls:

Vertical Current	
Collector mA	0.01
0.1 \times button	Pressed in
Vertical Position	No-load trace at graticule centerline.
Applied Voltage Polarity	—

8. The set-up of part 7 gives a vertical deflection factor of 0.001 mA/Div, and will probably include some hum loops as shown in the third quadrant of Fig. 4-4.

The 0.1 \times button in the Vertical Current block can be released while the test leads are being attached to the correct test terminals of the Sampling Gate, and then pressed to make the measurement.

Connect the leads to check each individual diode reverse leakage. Checking reverse leakage of three in series might not give an indication that one is bad. Any one diode that shows any discernible leakage (negative movement of Type 575 trace) is cause to reject a whole Sampling Gate assembly.

Test points are listed in Table 4-1 for all six diodes.

TABLE 4-1

Individual Sampling Gate diode test terminals for reverse leakage checking.

Diode	Terminals	
	+	-
D2A	J51	K
D2B	K	L
D2C	L	Ground
D2D	Ground	I
D2E	I	J
D2F	J	J53

Major Circuits and Parts Locations

The remainder of this section includes photographs of sections of the Type S-4. Major circuit areas are identified. All components mounted on circuit boards are identified by circuit numbers.

Replacing the Sampling Head Case

To replace the case on the sampling head, align the body so that the hole in the side appears over the Gate Bal control at the rear of the Preamp Board. Check that the upper and lower corners of the Preamp and Strobe boards are aligned with the channels in the sampling head body which contain the zigzag springs. Push the body gently forward until it contacts the front panel. Be sure that the white plastic pawl on the locking knob is properly aligned as the sampling head unit is slid into the body. In attaching the rear casting, be sure that the hole at one side of the casting fits over the trigger pickoff signal output connector. Insert the four long mounting bolts and tighten them securely.

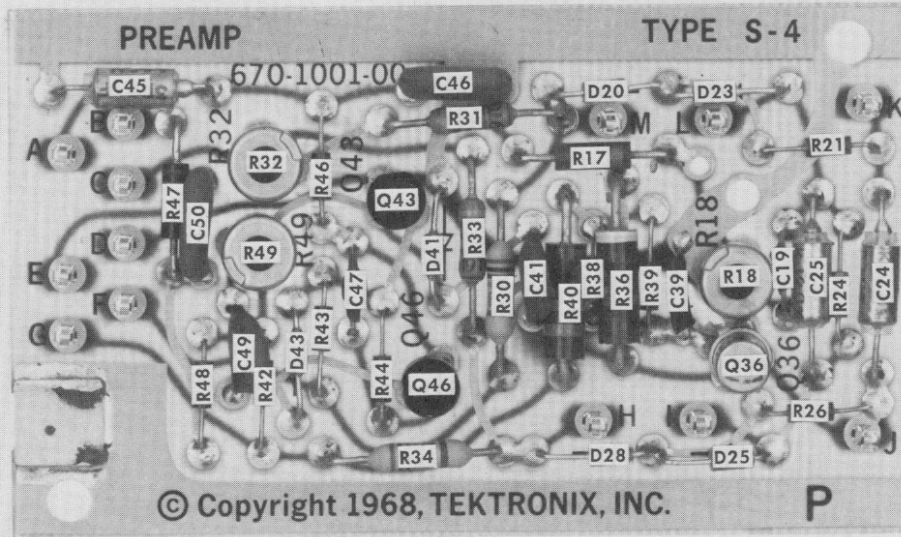
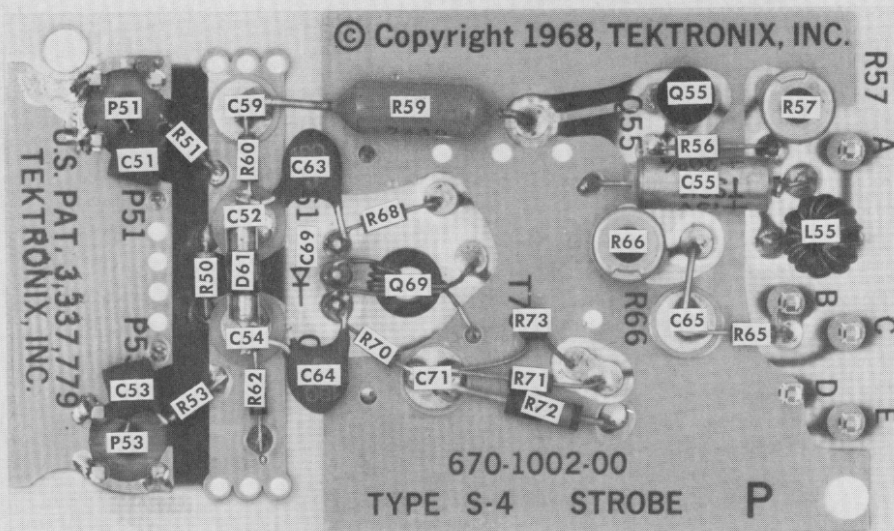

Fig. 4-6. Preamp circuit board.



R52, R54, and Q69 mounted on under-side.

Fig. 4-7. Strobe circuit board.

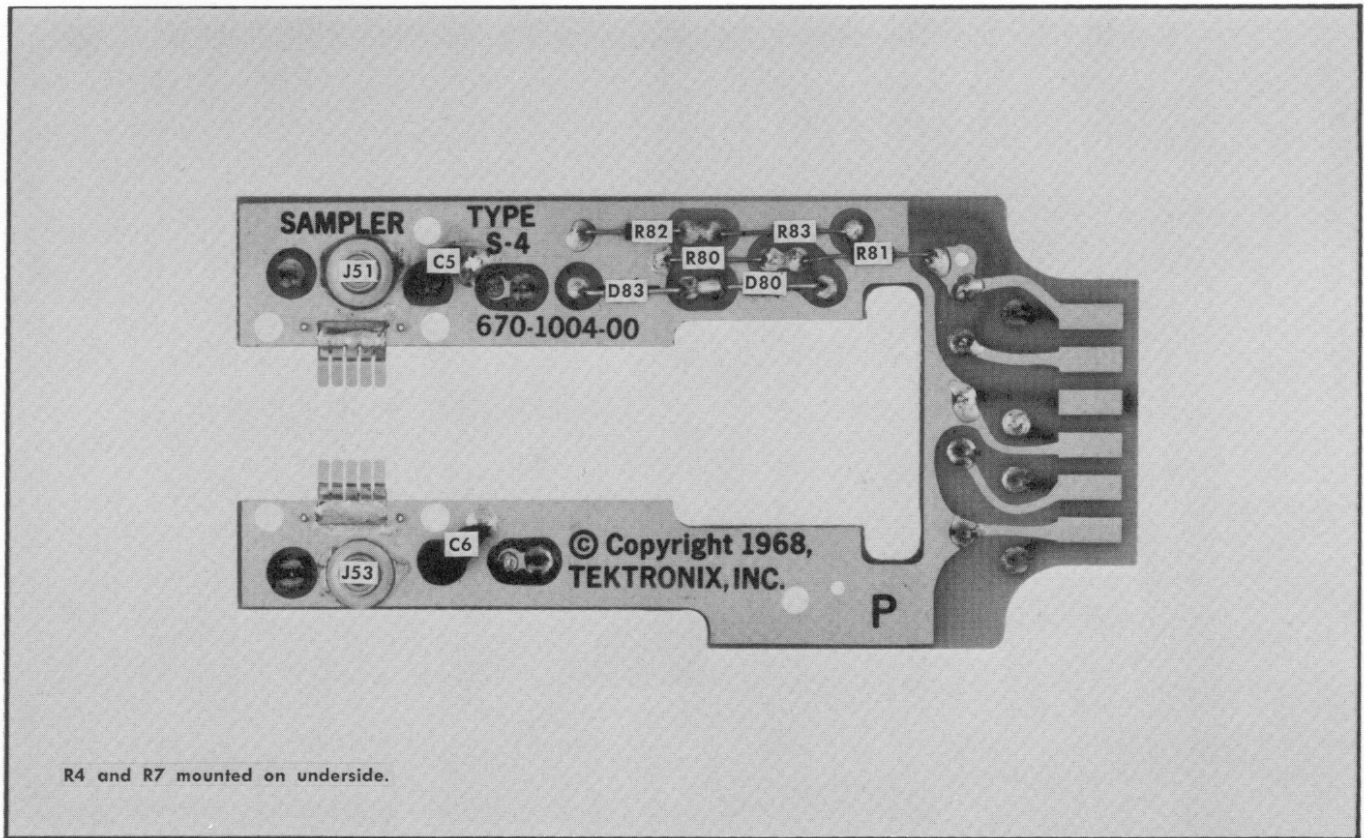

Fig. 4-8. Sampler circuit board.

SECTION 5

PERFORMANCE CHECK / CALIBRATION

Change information, if any, affecting this section will be found at the rear of the manual.

Introduction

Performance of the Type S-4 can be checked without making internal adjustments by using the steps of this procedure whose headings are set in the type face used in step 1. Failure to meet the requirements given in any check indicates the need for calibration and/or repair.

The sampling head performance can be restored to the limits stated in Section 1 by performing the calibration steps of this procedure. Calibration steps are headed by the type face shown in step 2. Any needed maintenance should be performed before proceeding with calibration.

Since the sampling head functions as a part of the associated sampling unit, the sampling unit calibration must be correct before starting this procedure. It is recommended that the performance checks for the sampling unit be performed and any faults corrected just before the Type S-4 performance checks are made.

EQUIPMENT REQUIRED

This performance check and calibration procedure for the Type S-4 Sampling Head requires the use of the test equipment listed below and shown in Fig. 5-1. The test equipment specifications given are the minimum acceptable for the particular use of each item. If other test equipment is substituted, it must meet or exceed the requirements stated. All test equipment must be correctly calibrated.

All equipment items listed, except items 15, 16 and 17 can be obtained by ordering through your local Tektronix Field Engineer or Representative.

1. Indicator Oscilloscope, with proper sampling plug-in units, such as a Type 561A or Type 561B Oscilloscope with Type 3S2 Sampling Unit and Type 3T2 Random Sampling Sweep.

2. Test Oscilloscope. Requirements: bandwidth DC to at least 30 MHz, minimum deflection factor of 0.5 V/div. For example, a Tektronix Type 545B with Type 1A2 Dual-Trace Plug-In Unit.

3. 10 \times Probe for use with test oscilloscope. Tektronix P6012 Probe recommended with the Type 1A2 Dual-Trace Plug-In Unit. Tektronix Part No. 010-0203-00.

4. Signal Generator-Pulse Generator, such as the Tektronix Type 284 Pulse Generator used in this procedure. Requirements: Pulse risetime 70 ps or less, amplitude approximately 20 mV into 50 Ω , with a 180 mV positive-going trigger signal available at least 75 ns in advance of the pulse. Trigger signal risetime must be ≤ 400 ps. The generator must supply square wave signal outputs of 1 μ s period (1MHz) and 100 ns (10 MHz) at 100 mV and 1.0 V amplitudes into 50 Ω . (If your Type 284 Lead Time switch is labeled 5 ns-50 ns, order modification kit, Tektronix Part No. 040-0487-00.)

5. Pulse Generator with risetime 25 ps or less, such as the Tektronix Type S-50 Pulse Generator Head. Requirements: Risetime ≤ 25 ps, amplitude $\leq +400$ mV into 50 Ω , with a 180 mV positive-going trigger signal available at least 75 ns in advance of the fast pulse. Trigger signal risetime must ≤ 400 .

6. Solid coaxial line with 3 mm connectors, Tektronix Part No. 015-1015-00.

7. GR 874 to 3 mm adapter plug, Tektronix Part No. 015-1007-00.

8. GR 874 to 3 mm adapter jack, Tektronix Part No. 015-1008-00.

9. 50 Ω 2 \times coaxial attenuator, GR 874 connectors, such as GR 874-G6. Tektronix Part No. 017-0080-00.

10. A special variable attenuator with GR 874 connectors. It consists of a 100 Ω potentiometer across the 50 Ω line, and does not have a guaranteed response. Tektronix Part No. 067-0511-00.

11. 50 Ω coaxial cable with BNC connectors, approximately 40 inches long. Tektronix Part No. 012-0057-01.

12. Coaxial cable, BSM to BNC connectors, type RG58 cable, 18 inch length. Tektronix Part No. 012-0127-00.

13. Special 3 foot flexible extender cable for operating the sampling head outside the sampling unit. Tektronix Part No. 012-0124-00 required.

14. A clip lead to BNC adapter. Tektronix Part No. 013-0076-00.

15. DC Bridge for measuring 50 Ω . Requirements: plus or minus 5 volts maximum across 50 Ω resistor. Accurate within $\pm 0.5\%$. (Not shown.)

16. Small screwdriver, with insulated handle, $\frac{3}{32}$ inch bit, for adjusting screwdriver-adjust controls. (Not shown.)

17. An RMS reading line voltage meter, accurate within $\pm 3\%$ at the line voltage to which the indicator oscilloscope is connected. (Not shown.)

18. A sampling test oscilloscope, required to check strobe kickout, Step 13, such as a Type 561A Oscilloscope, Type 3T2 Random Sampling Sweep Unit, Type 3S2 Dual-Trace Sampling Unit and Type S-2 Sampling Head. (Not shown.) A second 50 Ω coaxial cable with BNC connectors, item 11, is also required.

PERFORMANCE CHECK AND CALIBRATION RECORD AND INDEX

The following abridged procedure may be used as a guide by the experienced technician for checking and/or calibrating the Type S-4 Sampling Head. The step numbers and titles are identical to those in the complete procedure.

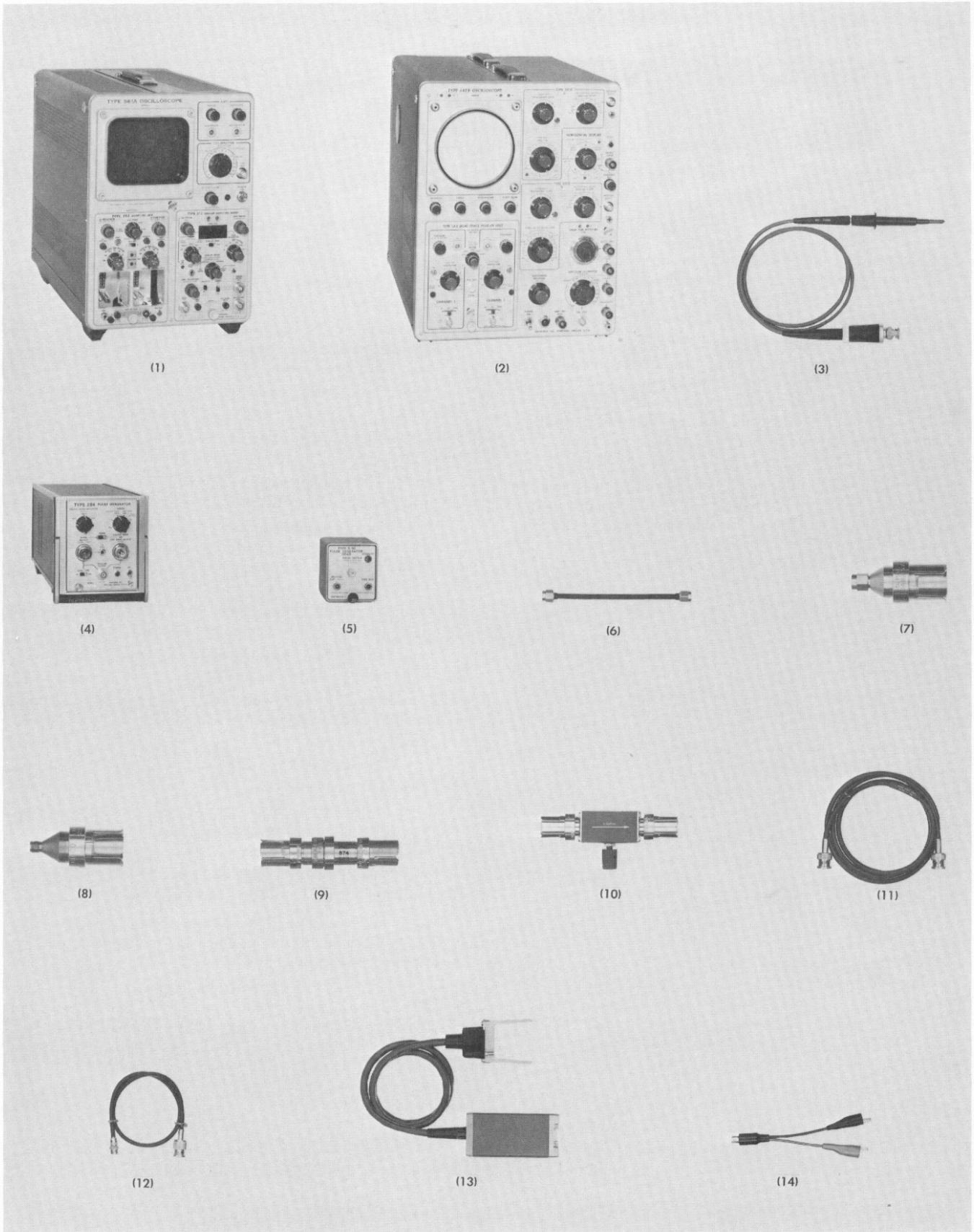

Fig. 5-1. Equipment required for calibration of the Type S-4.

The abridged procedure can be used as a maintenance record (the procedure may be reproduced without special permission of Tektronix, Inc.).

Type S-4 Sampling Head Serial No. _____

Calibration Date _____

Calibrated By _____

Checked By _____

- 1. Check Ability to Produce a CRT Display (Page 5-4)
- 2. Check Strobe Operation (Page 5-5)
- 3. Adjust Avalanche Volts and Snap-Off Current (Page 5-5)
- 4. Adjust Gate Bal (Page 5-6)
- 5. Check Dot Transient Response (Page 5-6)
- 6. Adjust Gain (Page 5-7)
- 7. Check Maximum Operating Signal Voltage (Page 5-7)
- 8. Check Displayed Noise (Tangential) (Page 5-7)
- 9. Check Risetime (Page 5-8)
- 10. Check Pulse Flatness Deviation (Page 5-9)
- 11. Adjust Transient Response (Page 5-10)
- 12. Check Baseline Shift With Repetition Rate Change (Page 5-10)
- 13. Check or Adjust Strobe Kickout (Page 5-10)

PRELIMINARY PROCEDURE

1. Check the 50 Ω DC Input Resistance. With the sampling head separated from the sampling unit, use a DC Resistance Bridge and measure the DC input resistance. Connect one lead to the input connector outer conductor, and the other lead to the center conductor. Be sure the bridge does not apply more than ±5 volts to the input terminals.

The Type S-4 input resistance must be 50 Ω, ±5%, for a resistance reading of 47.5 Ω to 52.5 Ω.

Complete any needed repairs to the sampling head before proceeding.

2. Setting up the equipment.

a. Assemble the indicator oscilloscope system. Place the Type 3S2 (or other sampling unit) into the left compartment of the indicator oscilloscope, and the Type 3T2 (or other sampling sweep unit) into the right compartment. Install an operating sampling head into the Type 3S2 Channel B compartment. Leave the Channel A compartment vacant.

b. Connect the RMS line-voltage meter to the power mains. Determine that the oscilloscope (and other equipment) input voltage selector is set for the correct value of line voltage. Connect all the equipment to the proper power outlet and turn on the power.

c. Obtain a free-running trace on the indicator oscilloscope and let the equipment warm up for five minutes. After the warm-up period, adjust the Trace Alignment control so the free-run trace is parallel to the graticule lines.

d. Connect the Type 284 Square Wave Output connector to the Channel B sampling head input. Use a 5 ns signal delay 50 Ω coaxial cable with GR 874 connectors. Connect the Type 284 Trigger Output connector to the sampling sweep unit External Trigger input (50 Ω) connector, using a BNC 50 Ω coaxial cable.

Set the Type 284 Period at 100 ns Square Wave and the Amplitude at 1 volt. Using the Type 284 as both a time and amplitude reference adjust both the vertical and the horizontal unit screwdriver adjustable Gain controls for proper deflection factor of each unit.

e. Install the Type S-4 onto the special three foot extender cable. Connect the other end of the cable into the Type 3S2 Channel A sampling head compartment. Allow a five minute warm up of the system.

NOTE

The case should be in place unless access to internal controls is necessary.

f. Set the controls as listed following Fig. 5-2.

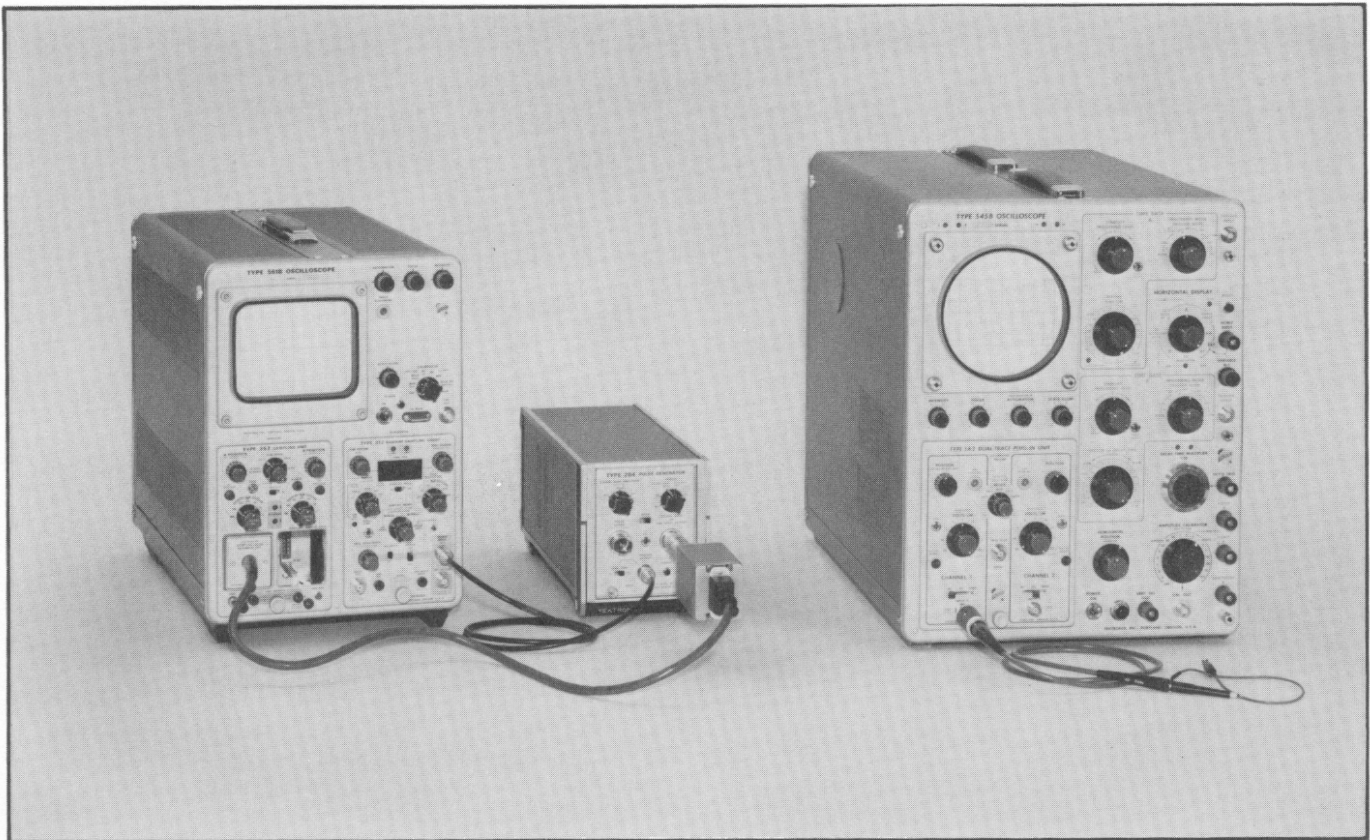

Fig. 5-2. Initial equipment setup.

Sampling Unit (Both channels)

Mode Switch	CH A
Dot Response	Midrange
Units/Div	100
Variable	Cal
Invert	Pushed in
Position	Midrange
DC Offset	0 volts at Offset Out
Horiz Plug-in Compatibility (Internal)	Sampling

Sampling Sweep Unit

Display Mode	Normal
Start Point	With Trigger
Time/Div	50 ns
Range	1 μ s
Time Magnifier	$\times 2$
Variable	Cal
Display Mag	$\times 1$
Time Position controls	Fully clockwise
Horiz Position	Midrange
Trig Sensitivity	Stable Display
Recovery Time	Optional
Trigger Polarity	+
Trigger Source	Ext
Samples/Div	100, Dot at 9 o'clock

Type 284

Mode	Square Wave
Period	100 ns
Square Wave Amplitude	1.0 V
Lead Time	75 ns

Test Oscilloscope

Triggering	+ Int, AC
Time/Div	0.2 μ s
Vertical	
With 10 \times Probe	1.0 V/Div, AC

PERFORMANCE CHECK AND CALIBRATION PROCEDURE

1. Check Ability to Produce a CRT Display

a. Connect the Type 284 Square Wave Output signal to the Type S-4 as shown in Fig. 5-2. Use a 2 \times GR attenuator at the Type 284 Output connector and a GR to 3 mm adapter to the Type S-4 Input connector.

b. Check the CRT for a normal square wave display. If the display is normal, proceed to step 3. If there is no display, perform step 2.

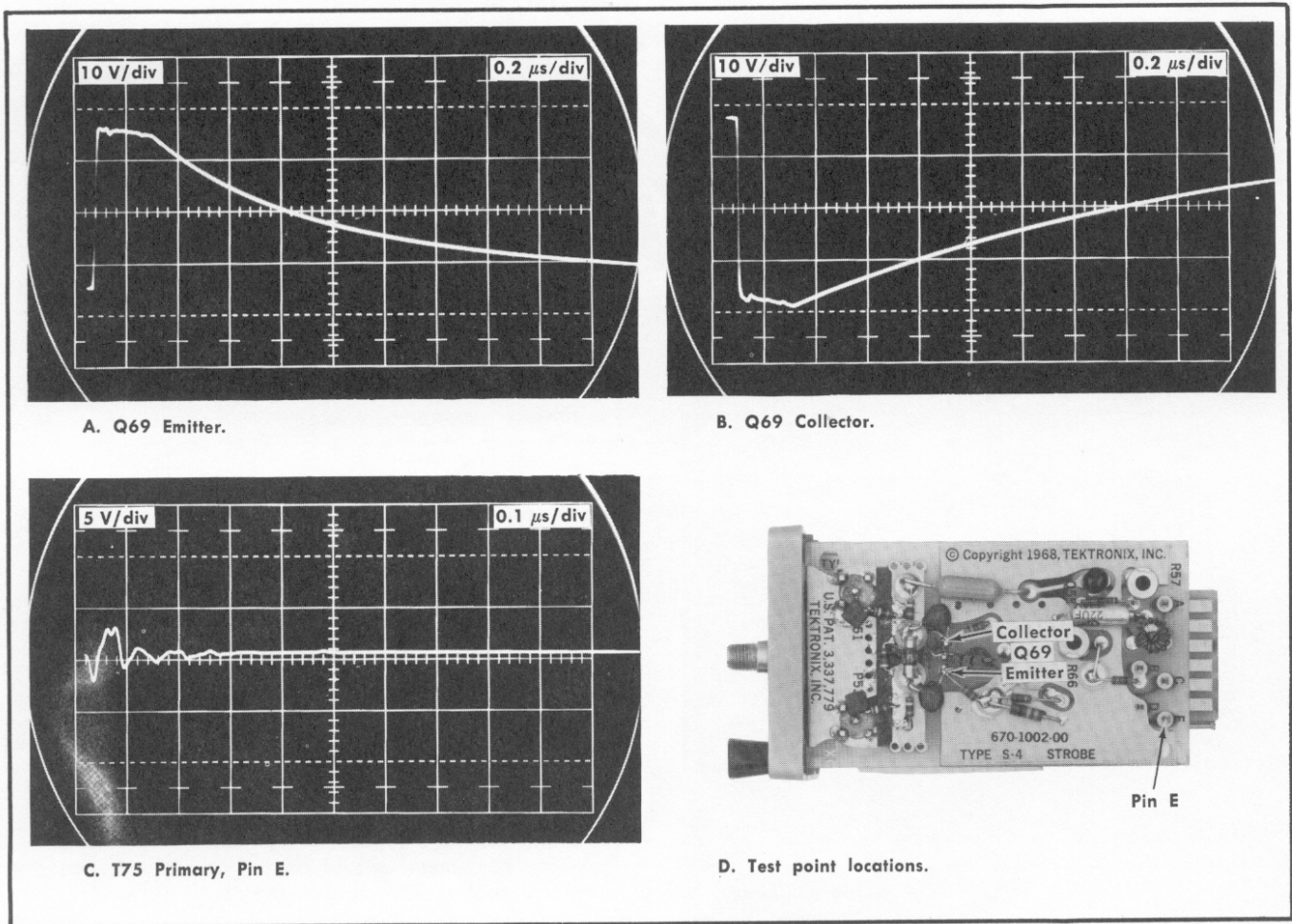

Fig. 5-3. Typical displays for Q69 operation.

2. Check Strobe Operation

a. Remove the extender cable from the sampling head (the indicator oscilloscope power may be left on).

b. Remove the Type S-4 case. First, remove the four round-head screws visible at the back casting, then slide the cover off by gently pulling it away from the front casting and input connector.

c. Reconnect the extender cable to the Type S-4. Use care to properly align the Trigger Pickoff connector.

d. Check for proper strobe operation by connecting a $10\times$ probe from the test oscilloscope to the emitter of Avalanche transistor Q69. Amplitude of the waveforms is affected by adjustment of Avalanche Volts control R66. Check the waveforms at the collector of Q69 and at the Primary of T75 (Pin E of the Strobe Board). Typical displays are shown in Fig. 5-3.

If T75 is receiving drive, but there is no signal out of Q69, change Q69. Turn the power off before removing the Strobe Board.

3. Adjust Avalanche Volts and Snap-Off Current

Avalanche Volts control R66 alters the strobe pulse amplitude and risetime. These in turn affect the display noise, balance, and dot transient response. Snap-Off control R57 affects display noise, balance, and strobe kick-out.

a. Disconnect the $2\times$ GR attenuator from the Type 284. Leave the attenuator and adapter attached to the Type S-4.

b. Set the Type 3T2 Trigger Sensitivity control for a free-running trace.

c. Set Avalanche Volts control R66 (see Fig. 5-4) and Snap-Off Current control R57 to midrange.

d. Turn the Avalanche Volts control R66 clockwise into the free-run position. The trace will become very noisy. Turn R66 counterclockwise about 30 degrees or more from the free-run position.

e. Set Snap-Off Current control R57 for the minimum amount of current to center the trace on the CRT. This will appear as the first nulling as the trace moves on the CRT with clockwise rotation of R57.

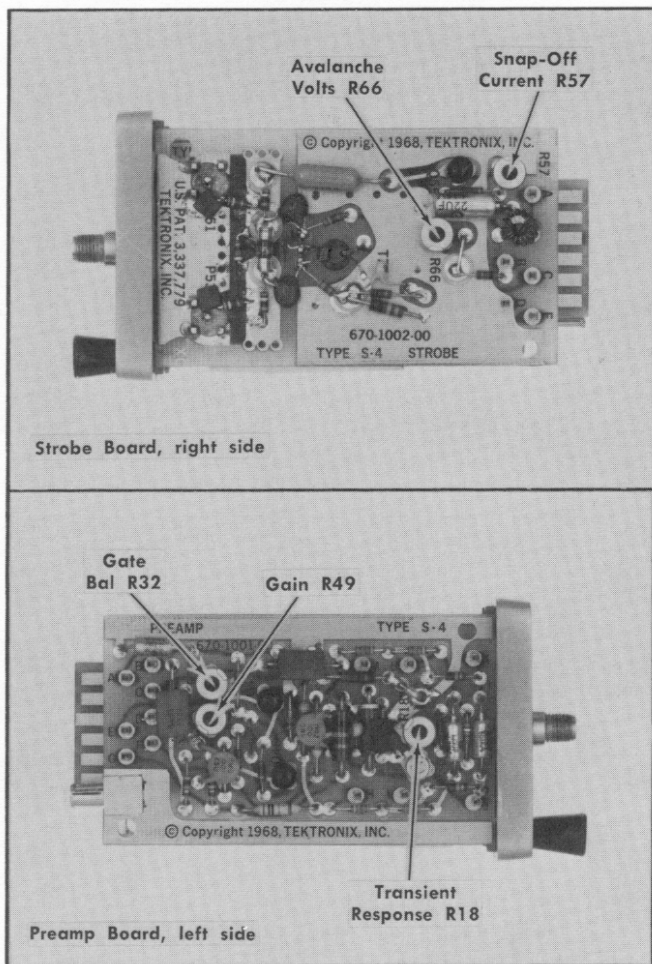

Fig. 5-4. Type S-4 internal control locations.

f. Fine adjustment of the controls is made for maximum loop gain and best dot transient response linearity. Connect the Type 284 Square Wave Output to the Type S-4 Input connector through the 2× attenuator and 3 mm to GR adapter.

g. Set the sampling sweep unit Start Point switch to Before Trigger, the sweep rate to 20 ns/div (Time Magnifier switch to ×5) and obtain a triggered display. The display may show greater than unity loop gain as a double trace. See Fig. 5-5.

h. Set the Avalanche Volts, R66, and the Snap-Off Current, R57, controls for maximum loop gain (two traces on the square wave) and linearity (difference at upper and lower trace separations should be equal).

i. Disconnect the 2× attenuator from the Type 284. Leave the attenuator and adapter attached to the Type S-4.

4. Adjust Gate Bal



Gate Bal control R32 introduces an internal offset voltage to the feedback loop to cancel normal error signals in the sampling loop, including normal unbalance in the traveling wave gate. R32 is adjusted (with DC Offset at zero) to

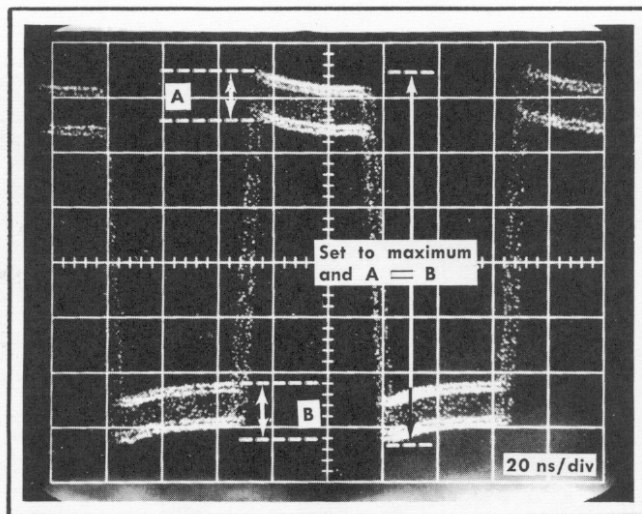

Fig. 5-5. Fine adjustment of Avalanche Volts and Snap-Off Current, step 3.

cancel most of the vertical trace shift as the Units/Div switch setting is changed.

a. Set the sampling unit DC Offset control for zero volts at the Offset Out jack.

b. Observe the trace as the sampling unit Units/Div switch is operated through its ranges and adjust Gate Bal control R32 for no more than one division of vertical shift of the trace. This adjustment varies with changes in the extender cable and when the Type S-4 case is removed or replaced. The Gate Bal control should be readjusted each time the equipment configuration is changed (cable moved or Type S-4 cover removed or replaced).

c. Set the sampling unit Units/Div switch to 100.

5. Check Dot Transient Response

Requirement—Dot will move full amplitude ±5%, of any signal up to 500 mV peak to peak when sampling sweep unit is either double triggered or free run.

a. Connect the Type 284 Square Wave Output connector to the Type S-4 Input connector with the 2× GR attenuator or variable attenuator and 3 mm to GR adapter.

b. Connect the coaxial cable from the Type 284 Trigger Output to the sampling sweep Trigger Input connector.

c. Set the Type 284 Period switch to 100 ns (set it to 1 μs when the sampling sweep unit is other than a Type 3T2). Set the Type 3T2 Range switch to 10 μs, the Time Magnifier to ×50 and the Start Point switch to With Trigger.

d. Set the sampling unit Units/Div switch to 100 and obtain a triggered square wave display.

e. Set the Type 3T2 Start Point switch to Before Trigger (or free run the sampling sweep unit at 0.5 μs/div if not a Type 3T2). Obtain a triggered display.

f. Set the sampling unit Dot Response so the top of the square wave is at unity loop gain (one trace). The bottom

of the square wave can show two traces, but the dot response overshoot or undershoot must not be greater than 5%, or 0.25 major division on the graticule (see Fig. 5-6).

If the dot response overshoots or undershoots more than 5%, perform step 6.

6. Adjust Gain

Gain control R49 changes the feedback loop gain.

a. Use the same setup as the preceding steps. Set the sampling unit Dot Response control to its electrical midpoint. The electrical midpoint is found by watching the changes in the display with greater or less than unity loop gain and setting the Dot Response control half-way between maximum loop gain and minimum loop gain.

b. Adjust Gain control R49 for unity loop gain as shown in Fig. 5-6.

Fine adjustment of Avalanche Volts control R66 and Snap-Off Current control R57 for the best dot transient response with minimum noise may correct a dot response overshoot or undershoot in excess of the 5% tolerance. Sampling gate replacement may cause unbalanced response. See step 13 for adjustment of strobe pickoff resistors R51 and R53.

7. Check Maximum Operating Signal Voltage

Requirement—Signal amplitude up to 1 V peak to peak must be displayed without distortion.

a. Connect the Type 284 Square Wave Output to the Type S-4 through a 3 mm to GR adapter and the solid coaxial 3 mm line.

b. Connect the Type 284 Trigger Output to the sampling sweep Trigger Input.

c. Set the sampling unit Units/Div switch to 20. Set the Type 284 Period switch to 1 μ s and the Amplitude switch to 100 mV.

d. Set the sampling sweep unit for a 200 ns/div sweep, the Trigger Mode switch to With Trigger and obtain a stable display. Observe the top and bottom portions of the display.

e. Change the Units/Div switch to 200 and the Type 284 Amplitude switch to 1.0 V.

f. Check that the square wave display is not distorted at the top or bottom portions as observed in part d.

A distorted Square Wave display may be caused by Gate unbalance. Check step 4, Adjust Gate Bal, or replace the substrate assembly, see the Maintenance section.

g. Remove the 3 mm GR adapter and the solid coaxial 3 mm line.

8. Check Displayed Noise (Tangential)

NOTE

When making a visual noise reading from a sampling display, the eye interprets a noise value which

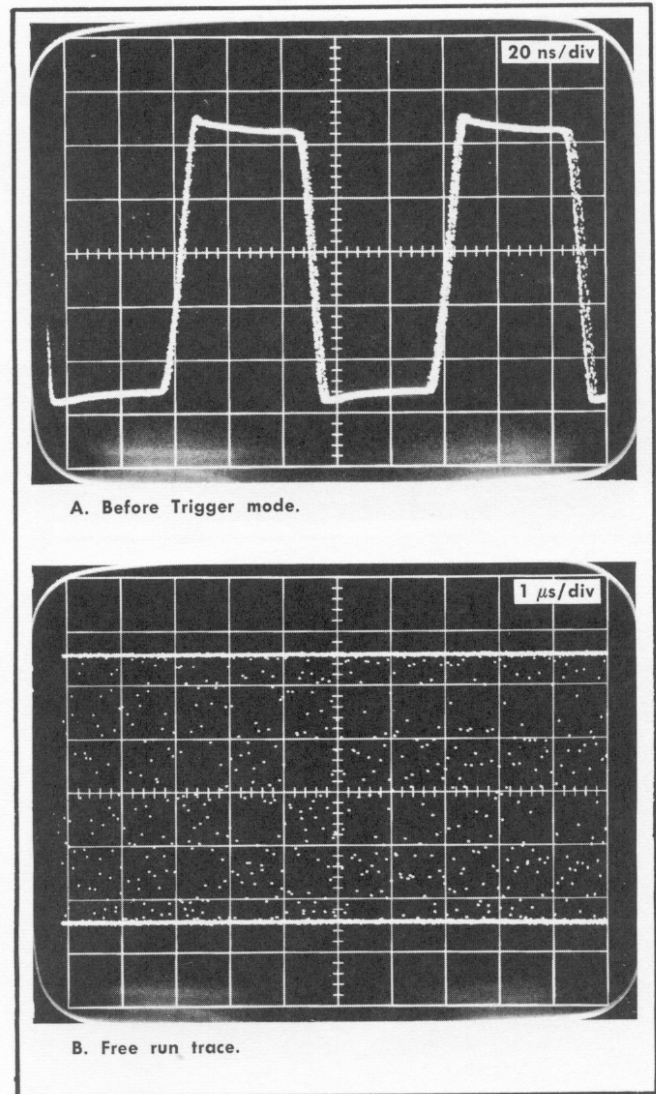

Fig. 5-6. Dot Transient Response check.

is neither the RMS nor the peak-to-peak value. Since most observers agree that the displayed noise value is approximately 3 times the RMS value, the Tangential Noise here defined is 3 times the RMS value. (The measurement technique given produces acceptable agreement between various operators as to the instrument's noise value.)

Requirement—Tangential noise will be not greater than 5 mV, with the case on the Type S-4.

a. Connect the Type 284 Square Wave Output to the Type S-4 Input connector with the 2 \times GR attenuator, variable attenuator, and the 3 mm to GR adapter.

b. Set the sampling unit Units/Div switch to 10 and the Variable control to Cal.

Performance Check/Calibration—Type S-4

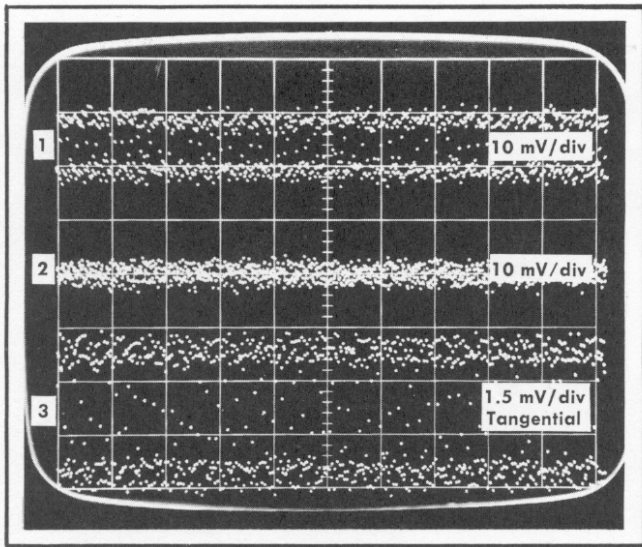

Fig. 5-7. Triple exposure of Tangential noise measurement.

c. Set the sampling sweep unit for a $1 \mu\text{s}/\text{div}$ sweep and the Trigger Sensitivity control clockwise for free run operation. Disconnect the coaxial cable to the Trigger Input connector.

d. Refer to Fig. 5-7 for displays of the following noise measurement procedure.

(1) Obtain a display of two traces.

(2) Adjust the variable attenuator until the two traces bend together just to the point at which they appear as one trace.

(3) Change the Type 284 Amplitude switch to 1.0 V, 10 times the signal amplitude. The display now has tangential deflection factor of 1.5 mV/div.

Tangential deflection factor per division is equal to the Units/Div setting of 10 mV divided by 2, times 3 divided by 10 = 1.5 mV/div.

The 5 mV tangential display noise limit includes 3.33 graticule divisions (3) of Fig. 5-7. Check that the bottom edges of the two traces are not more than 3.33 divisions apart. Waveform (3) measures as 3.6 mV tangential noise.

Determining Tangential Noise Deflection Factor.

The noise displays of Fig. 5-7 have a noise deflection factor based upon the signal amplitude, the sampling unit Units/Div setting, the fact that the final trace separation is twice the RMS noise, and that the tangential noise is 3 times the RMS noise. The square wave signal amplitude that makes two traces appear as one sets the trace separation to twice the RMS noise. The procedure used here then permits a noise deflection factor to be determined by dividing the input mV/div deflection factor by 2 (trace separation is 2 times the RMS noise), multiplying by 3 (tangential noise is 3 times the RMS noise) and then dividing by 10 (the signal amplitude change factor).

e. Disconnect the Type S-4 from the Type 284.

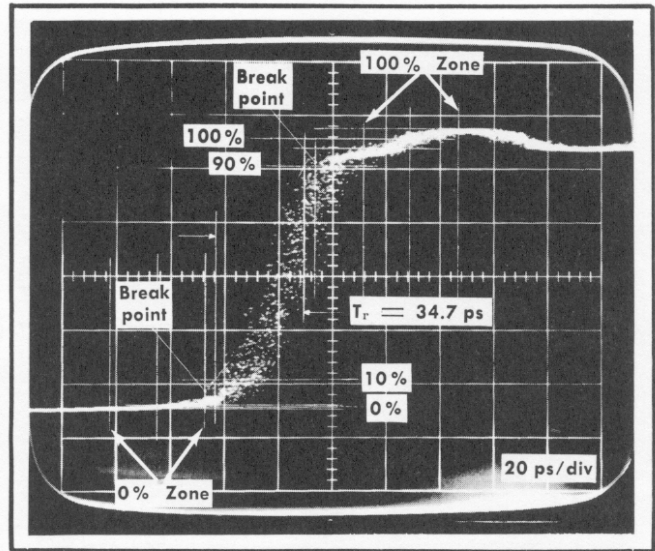

Fig. 5-8. Combination of Type S-4 and Type S-50 risetime measurement.

9. Check Risetime

Requirement—The 10% to 90% risetime is equal to or less than 25 ps, displayed as 35 ps or less using the Type S-50 Pulse Generator Head.

Risetime measurement requires either a camera or a storage oscilloscope because the dot density must be increased for an accurate display and the sweep becomes too slow for visual interpretation.

a. Install the Type S-4 in the sampling unit left compartment without the extender.

b. Set the sampling unit Units/Div switch to 100.

c. Connect the Type S-50 on the extender in the right compartment of the sampling unit. Connect the Pulse Output to the solid coaxial line and to the Type S-4 Input connector. Connect the BSM to BNC cable from the Type S-50 Pretrig Out connector to the sampling sweep unit 50Ω Trigger Input connector.

d. Set the sampling sweep unit for a 20 ps/div sweep rate (Range switch to 100 ns, Time Magnifier switch to $\times 50$ and the Display Mag switch to $\times 10$). Center the rising portion of the pulse on the graticule and obtain at least 100 dots per division. Photograph or store the display.

e. Measure the risetime as follows:

(1) Mark reference points at maximum rate of change, the break points shown in Fig. 5-8.

(2) Mark the centers of the 0% zone and 100% zone (the specified system risetime wide, 35 ps), 35 ps from the reference break points, shown in Fig. 5-8.

(3) Mark the average level of the 0% and 100% zones through the centers of the zones.

(4) Mark the 10% and 90% points in relation to the 0% and 100% average levels.

(5) Measure the risetime between the 10% and 90% points.

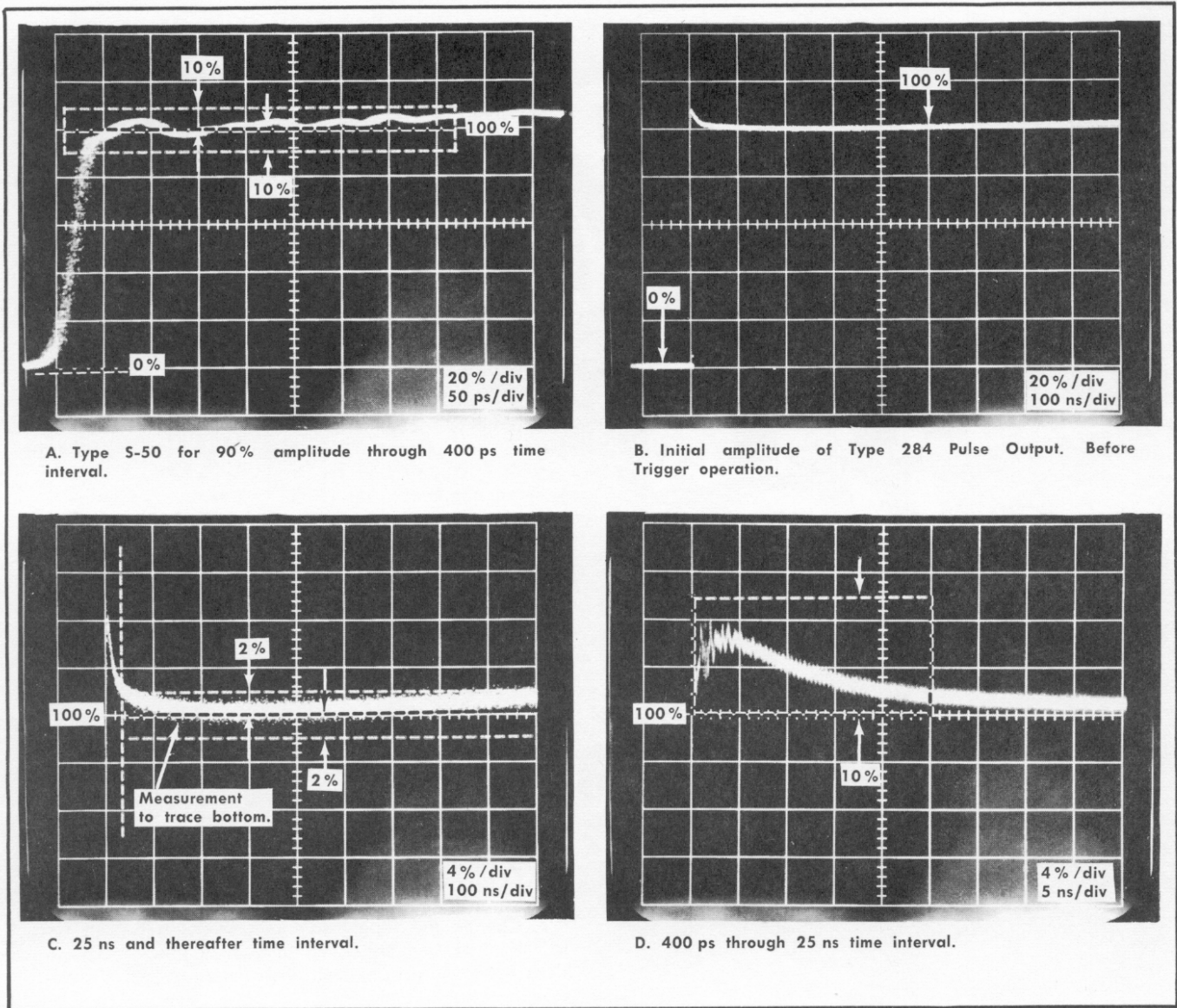

Fig. 5-9. Check of pulse flatness deviation, step 10.

- f. Check that the risetime is 35 ps or less.
- g. Use the same display and setup for the pulse flatness deviation check, step 10.

10. Check Pulse Flatness Deviation

- Requirement—Pulse will deviate from the flat;
- First 400 ps after step, -10% , $+10\%$ or less, total less than 20% peak to peak;
 - Between 400 ps and 25 ns after step, 0% , $+10\%$ or less, total less than 10% peak to peak;
 - After 25 ns, $+2\%$, -2% or less, total less than 4% peak to peak.

The Type S-50 is used to determine pulse flatness deviation during the first 400 ps and the Type 284 is used after the first 400 ps.

Measurement of the pulse flatness deviation during the first 400 ps requires either a camera or a storage oscilloscope because the dot density must be increased for an accurate display and the sweep becomes too slow for visual interpretation, as in the check of risetime.

- a. Use the same setup as in step 9 and set the 100% zone on a graticule line. Change the sampling sweep unit sweep rate to 50 ps/div (Time Magnifier switch to $\times 20$) and Time Position the display so the 90% amplitude point is near the first division on the graticule.
- b. Check that the pulse does not deviate from the 100% level more than $+10\%$ or -10% (total of 20% peak to peak) during the first 400 ps, see Fig. 5-9A. 10% is about a half division.
- c. Disconnect the Type S-50 from the solid coaxial line.

Performance Check/Calibration—Type S-4

d. Connect the Type 284 Pulse Output connector to the Type S-4 Input connector through a 3 mm to GR adapter and the 3 mm solid coaxial line. Set the Type 284 Mode switch to Pulse Output. Connect the Type 284 Trigger Output to the sampling sweep unit 50 Ω Trigger Input connector through a BNC coaxial cable.

e. Set the sampling sweep unit sweep rate to 100 ns/div (Range switch to 1 μ s, Display Mag switch to $\times 1$ and the Time Magnifier switch to $\times 1$). Set the Start Point switch to Before Trigger and obtain a stable display.

f. Use the sampling sweep unit Time Position control to place the rising portion of the pulse one division from the left edge of the graticule. Set the sampling unit Variable Units/Div control for 5 divisions between the 0% amplitude and the 100% amplitude level. See Fig. 5-9B. Use the point 50 ns before the pulse as 0% and the point 500 ns after the pulse as 100%.

g. Change the Units/Div switch (without moving the Variable control) to 20 or a signal amplitude now 4% per division.

h. Position the trace bottom at the 100% (500 ns after pulse rise) amplitude point on the center graticule line.

i. Check the pulse flatness deviation from 25 ns after pulse rise through end of the pulse. (The Time Position control may be used.) See Fig. 5-9C.

j. Check that the pulse flatness deviation is not more than +2%, -2% (total of 4% peak to peak). If the deviation is more than specified, perform step 11, Adjust Transient Response.

k. Set the sampling sweep unit sweep rate to 5 ns (Range switch to 100 ns and Time Magnifier switch to $\times 2$) and set the Start Point switch to With Trigger.

l. Reposition the rising portion of the pulse one division from the left edge of the graticule. Check the pulse flatness deviation from 400 ps to 25 ns after the pulse rise. See Fig. 5-9D.

m. Check that the pulse flatness deviation is not more than 0%, +10% or total 10% peak to peak.

n. Use the same setup to perform the Transient Response adjustment. Disconnect the Type 284 with the solid coaxial line from the Type S-4 and remove the BNC coaxial cable from the sampling sweep Trigger Input. Proceed to step 12.

11. Adjust Transient Response



Transient Response control R18 adjusts the magnitude of the blow-by correction signal; it does not change risetime.

a. Use the same setup as the pulse flatness deviation check, parts d through j.

b. Adjust Transient Response R18 so the pulse flatness does not deviate more than +2% or -2%, total 4% peak to peak, in the interval following 25 ns after the pulse rise. See Fig. 5-9C.

c. Disconnect the Type 284 with the solid coaxial line from the Type S-4 Input and remove the BNC coaxial cable to the sampling sweep unit Trigger Input connector.

12. Check Baseline Shift With Repetition Rate Change

Requirement—A no-signal trace will not shift vertically more than 10 mV when the sampling sweep unit external trigger rate is changed from 30 Hz to 50 kHz.

a. Use the test oscilloscope as a trigger rate generator. Drive the sampling sweep unit external trigger input with the front panel +Gate signal (+20 volts peak). Connect the +Gate to the clip lead adapter and to the Type 3T2 1 M Ω /UHF SYNC connector and trigger on the — polarity of the signal. (If the sampling sweep is other than a Type 3T2, place a 10 k Ω , 1/2 watt resistor between the test oscilloscope +Gate terminal and the sampling sweep external 50 Ω Trigger Input connector to provide 100 mV of triggering signal.)

Set the test oscilloscope sweep controls for a free run sweep. To obtain a 30 Hz trigger signal, set the Time/Div switch to 0.5 ms and the Variable time/div control to a position about 45° left of the top center. To obtain a 50 kHz trigger signal, set the Time/Div switch to 20 μ s and the Variable time/div control to a position 45° clockwise from bottom center.

b. Connect the 3 mm to GR adapter and 2 \times GR attenuator on the Type S-4 Input connector.

c. Set the sampling sweep unit for an external triggered sweep rate of 50 ns/div (to ensure that the shortest trigger circuit holdoff period is obtained and that the triggering rate can actually follow the external triggering signal repetition rate).

d. Set the sampling unit Units/Div switch to 10. Connect the external trigger rate generator signal to the sampling sweep unit and obtain a triggered sweep at either 30 Hz or 50 kHz repetition rate. Set the sampling unit DC Offset control to place the trace at one of the graticule lines.

e. Change the trigger rate generator through its ranges to the other frequency limit and check that the CRT trace does not move up or down farther than a total of one division.

f. If the trace moves too far, check the avalanche transistor, Q69. This requires starting the procedure at step 1.

g. Disconnect the Trigger Input cable from the test oscilloscope.

13. Check or Adjust Strobe Kickout

NOTE

Strobe kickout need to be checked only if the Sampling Gate substrate assembly or Strobe Board have been replaced.

a. Install the extender in Channel A and attach the Type S-4. Connect the Type S-4 Input connector through a 3 mm to GR adapter to the sampling test oscilloscope.

b. Connect the Type 284 Trigger Output to the indicator oscilloscope sampling sweep unit Trigger Input 50 Ω connector with a BNC cable. Set the Type 284 Mode switch to Pulse Output.

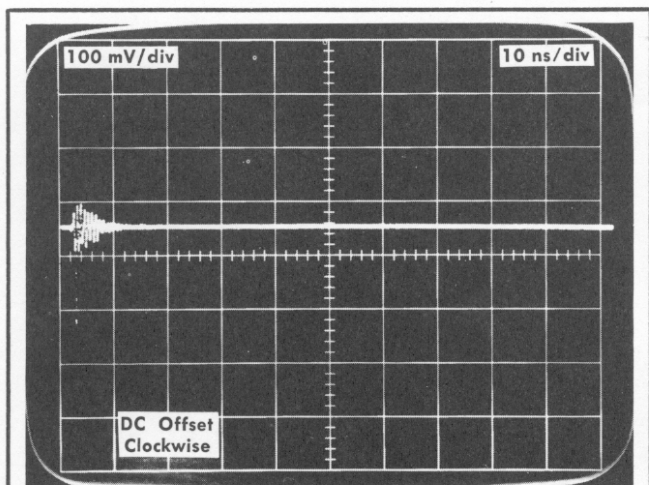

A. Locating the ringing portion.

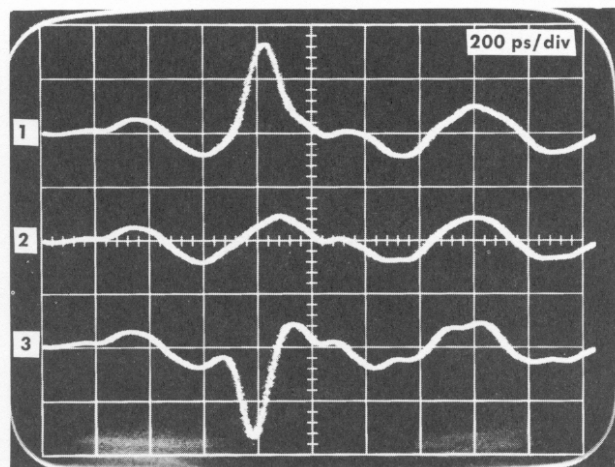

B. DC Offset control for Strobe kickout location.

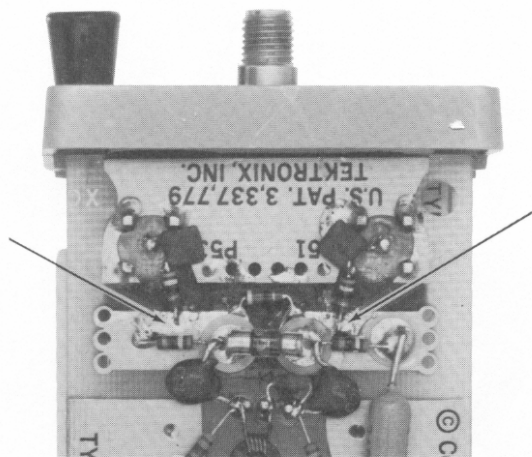

C. Location of the solder points.

c. Connect the Type 3T2 Pulse Out connector through a BNC cable to the External Trigger Input 50 Ω connector on the sampling test oscilloscope.

d. Set the indicator oscilloscope sampling sweep unit controls as follows:

Time Position	Midrange
Samples/Div	Any position
Time/Div	10 ns
Range	100 ns
Display Mode	Manual
Manual Scan	Midrange
Trigger Sensitivity	Fully counterclockwise
Recovery Time	Fully counterclockwise
Polarity	+
Source	Ext

e. Set the sampling test oscilloscope as follows:

Sampling Sweep Unit

Time/Div	10 ns
Samples/Div	100
Time Position	Midrange
Trigger Source	Ext
Slope	—
Sweep Mode	Normal
Trigger Sensitivity	10 o'clock

Sampling Unit

Millivolts/Div	100
DC Offset	Centered display
Other controls	Optional

f. Set the indicator oscilloscope sampling unit Units/Div switch to 2 and rotate the DC Offset control. The sampling test oscilloscope CRT display should show a spike in the ringing portion, positive for counterclockwise rotation and negative for clockwise rotation. This identifies the Strobe kickout. Place the ringing portion in the first division with the Time Position control, see Fig. 5-10.

g. Change the sampling test oscilloscope sweep rate to 200 ps/div. Fig. 5-10B shows the sampling unit (1) DC Offset control counterclockwise, (2) DC Offset control set for minimum of both strobos, and (3) DC Offset control set clockwise. Set the sampling unit DC Offset control for minimum amplitude of both strobos.

h. Set the sampling unit Units/Div switch to 100 and check the kickout. Amplitude up to a 50 mV peak is acceptable.

i. Reduce the kickout amplitude by moving the solder point on the clipping lines of R51 or R53. Since the solder points are at ground potential, the CRT display is observed

Fig. 5-10. Strobe kickout from the Type S-4 Input connector.

Performance Check/Calibration—Type S-4

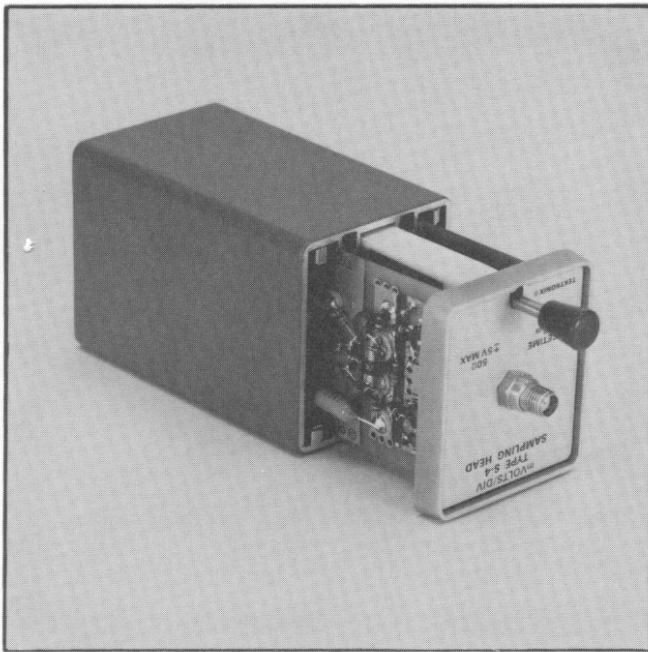

Fig. 5-11. Correct board and latch positions when re-installing the Sampling Head case.

as the lead is heated with a small soldering iron and moved with a soldering tool. Keep the solder points as close to R50 as possible. Fig. 5-10C shows the solder points on the clipping lines.

j. Set the sampling test oscilloscope at 1 ns/div (Time Magnifier at $\times 10$).

k. Set the indicator oscilloscope sampling unit Units/Div switch to 2 and the DC Offset control fully clockwise.

l. Check that the kickout occurs within 1.2 ns of the beginning of the ringing portion. If not, readjust the Snap-Off Current control (see Step 3 Adjust Avalanche Volts and Snap-Off Current).

The case on the Type S-4 may change the kickout amplitude from that observed with the case off. Desired minimum is with the case on the Type S-4 and several attempts should be made. Risettime should be checked after any solder point change.

Fig. 5-11 shows the correct board and latch position for re-installation of the case.

PARTS LIST ABBREVIATIONS

BHB	binding head brass	int	internal
BHS	binding head steel	lg	length or long
cap.	capacitor	met.	metal
cer	ceramic	mtg hdw	mounting hardware
comp	composition	OD	outside diameter
conn	connector	OHB	oval head brass
CRT	cathode-ray tube	OHS	oval head steel
csk	countersunk	PHB	pan head brass
DE	double end	PHS	pan head steel
dia	diameter	plstc	plastic
div	division	PMC	paper, metal cased
elect.	electrolytic	poly	polystyrene
EMC	electrolytic, metal cased	prec	precision
EMT	electrolytic, metal tubular	PT	paper, tubular
ext	external	PTM	paper or plastic, tubular, molded
F & I	focus and intensity	RHB	round head brass
FHB	flat head brass	RHS	round head steel
FHS	flat head steel	SE	single end
Fil HB	fillister head brass	SN or S/N	serial number
Fil HS	fillister head steel	SW	switch
h	height or high	TC	temperature compensated
hex.	hexagonal	THB	truss head brass
HHB	hex head brass	thk	thick
HHS	hex head steel	THS	truss head steel
HSB	hex socket brass	tub.	tubular
HSS	hex socket steel	var	variable
ID	inside diameter	w	wide or width
incd	incandescent	WW	wire-wound



PARTS ORDERING INFORMATION

Replacement parts are available from or through your local Tektronix, Inc. Field Office or representative.

Changes to Tektronix instruments are sometimes made to accommodate improved components as they become available, and to give you the benefit of the latest circuit improvements developed in our engineering department. It is therefore important, when ordering parts, to include the following information in your order: Part number, instrument type or number, serial or model number, and modification number if applicable.

If a part you have ordered has been replaced with a new or improved part, your local Tektronix, Inc. Field Office or representative will contact you concerning any change in part number.

SPECIAL NOTES AND SYMBOLS

- | | |
|---|---|
| ×000 | Part first added at this serial number |
| 00× | Part removed after this serial number |
| *000-0000-00 | Asterisk preceding Tektronix Part Number indicates manufactured by or for Tektronix, Inc., or reworked or checked components. |
| Use 000-0000-00 | Part number indicated is direct replacement. |
|  | Screwdriver adjustment. |
|  | Control, adjustment or connector. |

SECTION 6

ELECTRICAL PARTS LIST

Values are fixed unless marked Variable.

Ckt. No.	Tektronix Part No.	Serial/Model No. Eff Disc	Description		
Capacitors					
Tolerance $\pm 20\%$ unless otherwise indicated.					
C5	283-0047-00		270 pF	Cer	500 V 5%
C6	283-0047-00		270 pF	Cer	500 V 5%
C12	283-0121-00		0.001 μF	Cer	200 V
C19	283-0136-00		10 pF	Cer	50 V 5%
C24	290-0188-00		0.1 μF	Elect.	35 V 10%
C25	290-0267-00		1 μF	Elect.	35 V
C39	283-0051-00		0.0033 μF	Cer	100 V 5%
C41	283-0000-00		0.001 μF	Cer	500 V
C45	290-0246-00		3.3 μF	Elect.	15 V 10%
C46	283-0005-00		0.01 μF	Cer	250 V
C47	283-0066-00		2.5 pF	Cer	200 V
C49	283-0000-00		0.001 μF	Cer	500 V
C50	283-0005-00		0.01 μF	Cer	250 V
C51	283-0154-00		22 pF	Cer	50 V 5%
C52	283-0135-00		100 pF	Cer	
C53	283-0154-00		22 pF	Cer	50 V 5%
C54	283-0135-00		100 pF	Cer	
C55	290-0134-00		22 μF	Elect.	15 V
C59	283-0121-00		0.001 μF	Cer	200 V
C63	283-0103-00		180 pF	Cer	500 V 5%
C64	283-0103-00		180 pF	Cer	500 V 5%
C65	283-0121-00		0.001 μF	Cer	200 V
C69	283-0140-00		4.7 pF	Cer	50 V 5%
C71	283-0121-00		0.001 μF	Cer	200 V

Semiconductor Device, Diodes

D2A¹
D2B¹
D2C¹
D2D¹
D2E¹

D2F ¹					
D20	152-0333-00		Silicon		High speed and conductance
D23	152-0333-00		Silicon		High speed and conductance
D25	152-0333-00		Silicon		High speed and conductance
D28	152-0333-00		Silicon		High speed and conductance

¹Furnished as a unit with Hybrid Osc. Assembly (*155-0001-00).

Electrical Parts List—Type S-4

Semiconductor Device, Diodes (cont)

Ckt. No.	Tektronix Part No.	Serial/Model No. Eff	Disc	Description
D41	*152-0185-00		Silicon	Replaceable by 1N4152
D43	*152-0185-00		Silicon	Replaceable by 1N4152
D61	*152-0335-00		Silicon	Snap-off
D80	*152-0185-00		Silicon	Replaceable by 1N4152
D83	*152-0185-00		Silicon	Replaceable by 1N4152

Connectors

J1	131-0631-00		Receptacle, electrical
J3 ²			
J51	131-0391-01		Receptacle, electrical
J53	131-0391-01		Receptacle, electrical
P3	131-0663-00		Receptacle, electrical
P17	131-0565-00		Receptacle, electrical, male
P51	131-0582-00		Receptacle, electrical
P53	131-0582-00		Receptacle, electrical

Inductors

L10	276-0543-00		Core, ferrite
L14	276-0543-00		Core, ferrite
L55	*120-0382-00		Toroid, 14 turns single

Transistors

Q10	*151-0212-00		Silicon	Tek Spec
Q14	*151-0212-00		Silicon	Tek Spec
Q36	151-1012-00		Silicon	FET
Q43	151-0224-00		Silicon	2N3692
Q46	151-0224-00		Silicon	2N3692
Q55	151-0224-00		Silicon	2N3692
Q69	*153-0556-00		Silicon	Tek Spec

Resistors

Resistors are fixed, composition, $\pm 10\%$ unless otherwise indicated.

R2A ³					
R2B ³					
R2E ³					
R2F ³					
R4	315-0103-00		10 k Ω	1/4 W	5%

²Furnished as a unit with 10X Atten. (119-0178-00).

³Furnished as a unit with Hybrid Osc. Assembly (*155-0001-00).

Resistors (cont)

Ckt. No.	Tektronix Part No.	Serial/Model No. Eff	Disc	Description		
R7	315-0103-00		10 k Ω	1/4 W		5%
R10	317-0102-00		1 k Ω	1/8 W		5%
R11	317-0510-00		51 Ω	1/8 W		5%
R12	317-0511-00		510 Ω	1/8 W		5%
R13	317-0360-00		36 Ω	1/8 W		5%
R15	317-0102-00		1 k Ω	1/8 W		5%
R17	315-0152-00		1.5 k Ω	1/4 W		5%
R18	311-0643-00		50 Ω , Var			
R21	317-0224-00		220 k Ω	1/8 W		5%
R24	317-0393-00		39 k Ω	1/8 W		5%
R26	317-0224-00		220 k Ω	1/8 W		5%
R30	321-0385-00		100 k Ω	1/8 W	Prec	1%
R31	321-0253-00		4.22 k Ω	1/8 W	Prec	1%
R32	311-0609-00		2 k Ω , Var			
R33	321-0253-00		4.22 k Ω	1/8 W	Prec	1%
R34	321-0385-00		100 k Ω	1/8 W	Prec	1%
R36	301-0912-00		9.1 k Ω	1/2 W		5%
R38	307-0124-00		5 k Ω	Thermal		
R39	317-0202-00		2 k Ω	1/8 W		5%
R40	301-0103-00		10 k Ω	1/2 W		5%
R42	317-0224-00		220 k Ω	1/8 W		5%
R43	317-0223-00		22 k Ω	1/8 W		5%
R44	317-0122-00		1.2 k Ω	1/8 W		5%
R46	317-0101-00		100 Ω	1/8 W		5%
R47	315-0272-00		2.7 k Ω	1/4 W		5%
R48	317-0303-00		30 k Ω	1/8 W		5%
R49	311-0607-00		10 k Ω , Var			
R50	317-0470-00		47 Ω	1/8 W		5%
R51	317-0390-00		39 Ω	1/8 W		5%
R52	317-0101-00		100 Ω	1/8 W		5%
R53	317-0390-00		39 Ω	1/8 W		5%
R54	317-0101-00		100 k Ω	1/8 W		5%
R56	317-0271-00		270 Ω	1/8 W		5%
R57	311-0607-00		10 k Ω , Var			
R59	308-0243-00		240 Ω	3 W	WW	5%
R60	317-0390-00		39 Ω	1/8 W		5%
R62	317-0390-00		39 Ω	1/8 W		5%
R65	317-0101-00		100 Ω	1/8 W		5%
R66	311-0644-00		20 k Ω , Var			
R68	317-0332-00		3.3 k Ω	1/8 W		5%
R70	317-0332-00		3.3 k Ω	1/8 W		5%
R71	317-0202-00		2 k Ω	1/8 W		5%
R72	315-0203-00		20 k Ω	1/4 W		5%
R73	307-0124-00		5 k Ω	Thermal		
R80	317-0101-00		100 Ω	1/8 W		5%

Electrical Parts List—Type S-4**Resistors (cont)**

Ckt. No.	Tektronix Part No.	Serial/Model Eff	No. Disc	Description	
R81	317-0152-00		1.5 k Ω	1/8 W	5%
R82	317-0101-00		100 Ω	1/8 W	5%
R83	317-0182-00		1.8 k Ω	1/8 W	5%

Transformer

T75 *120-0544-00 Toroid, 2 windings

Integrated Circuit

*155-0001-00 Hybrid Gate Assembly

FIGURE AND INDEX NUMBERS

Items in this section are referenced by figure and index numbers to the illustrations which appear on the pullout pages immediately following the Diagrams section of this instruction manual.

INDENTATION SYSTEM

This mechanical parts list is indented to indicate item relationships. Following is an example of the indentation system used in the Description column.

Assembly and/or Component
Detail Part of Assembly and/or Component
mounting hardware for Detail Part
Parts of Detail Part
mounting hardware for Parts of Detail Part
mounting hardware for Assembly and/or Component

Mounting hardware always appears in the same indentation as the item it mounts, while the detail parts are indented to the right. Indented items are part of, and included with, the next higher indentation.

Mounting hardware must be purchased separately, unless otherwise specified.

PARTS ORDERING INFORMATION

Replacement parts are available from or through your local Tektronix, Inc. Field Office or representative.

Changes to Tektronix instruments are sometimes made to accommodate improved components as they become available, and to give you the benefit of the latest circuit improvements developed in our engineering department. It is therefore important, when ordering parts, to include the following information in your order: Part number, instrument type or number, serial or model number, and modification number if applicable.

If a part you have ordered has been replaced with a new or improved part, your local Tektronix, Inc. Field Office or representative will contact you concerning any change in part number.

Change information, if any, is located at the rear of this manual.

ABBREVIATIONS AND SYMBOLS

For an explanation of the abbreviations and symbols used in this section, please refer to the page immediately preceding the Electrical Parts List in this instruction manual.

INDEX OF MECHANICAL PARTS LIST ILLUSTRATIONS

(Located behind diagrams)

FIG. 1 EXPLODED

SECTION 7

MECHANICAL PARTS LIST

FIG. 1 EXPLODED

Fig. & Index No.	Tektronix Part No.	Serial/Model Eff	No. Disc	Q					Description
				†	1	2	3	4	
1-1	333-1097-00			1					PANEL, front
-2	386-1338-09			1					SUB-PANEL, front
	670-1001-00			1					ASSEMBLY, circuit board—PREAMP
	- - - - -			-					assembly includes:
-3	388-1039-00			1					BOARD, circuit
-4	136-0263-01			13					SOCKET, pin connector
-5	136-0252-01			10					SOCKET, receptacle (eyelet)
-6	210-0707-00			1					EYELET, metallic
-7	175-1042-01			1					ASSEMBLY, cable, w/connector & holder
-8	155-0001-00			1					ASSEMBLY, hybrid Gate (U1)
	- - - - -			-					mounting hardware: (not included w/assembly)
-9	211-0092-00			4					SCREW, 2-56 x 3/16 inch, HSS
-10	119-0178-00			1					TERMINATION, coaxial (R3, J3)
-11	131-0632-00			2					CONNECTOR, electrical, contact
-12	214-1072-00			2					SPRING, helical compression
-13	131-0631-00			1					CONNECTOR, OSM
	- - - - -			-					mounting hardware: (not included w/connector)
-14	220-0531-00			1					NUT, hex., 1/4-32 x 0.375 inch
-15	670-1003-00			1					ASSEMBLY, circuit board—TRIGGER TAKE OFF
	- - - - -			-					assembly includes:
	388-1041-00			1					BOARD, circuit
-16	131-0663-00			1					CONNECTOR
-17	210-0707-00			2					EYELET, metallic
-18	670-1004-00			1					ASSEMBLY, circuit board—SAMPLER
	- - - - -			-					assembly includes:
	388-1042-00			1					BOARD, circuit
-19	214-1081-00			4					PIN, spiral
-20	131-0391-01			2					CONNECTOR, male
-21	131-0591-00			12					TERMINAL, pin, 0.025 square x 0.84 inch long
-22	131-0594-00			3					TERMINAL, pin, 0.025 square x 1.485 inches long
-23	670-1002-00			1					ASSEMBLY, circuit board—STROBE
	- - - - -			-					assembly includes:
	388-1040-00			1					BOARD, circuit
-24	135-0263-01			5					SOCKET, pin terminal
-25	136-0252-01			6					SOCKET, pin connector
-26	344-0061-00			2					CLIP, diode
-27	131-0582-00			2					CONNECTOR, female
-28	384-0687-00			1					SHAFT, latch
-29	105-0066-00			1					STRIKE, latch
-30	380-0125-00			1					HOUSING
	- - - - -			-					housing includes:
-31	131-0555-00			4					CONTACT
-32	386-1337-04			1					PANEL, rear
	- - - - -			-					mounting hardware: (not included w/panel)
-33	211-0141-00			4					SCREW, 4-40 x 3 1/4 inches, PHS

SECTION 8

DIAGRAMS

Schematic Symbols

The following special symbols are used on the schematics:

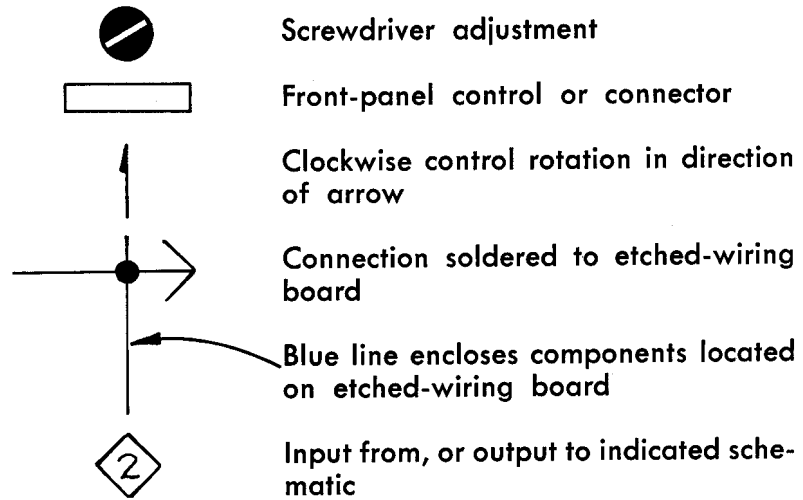

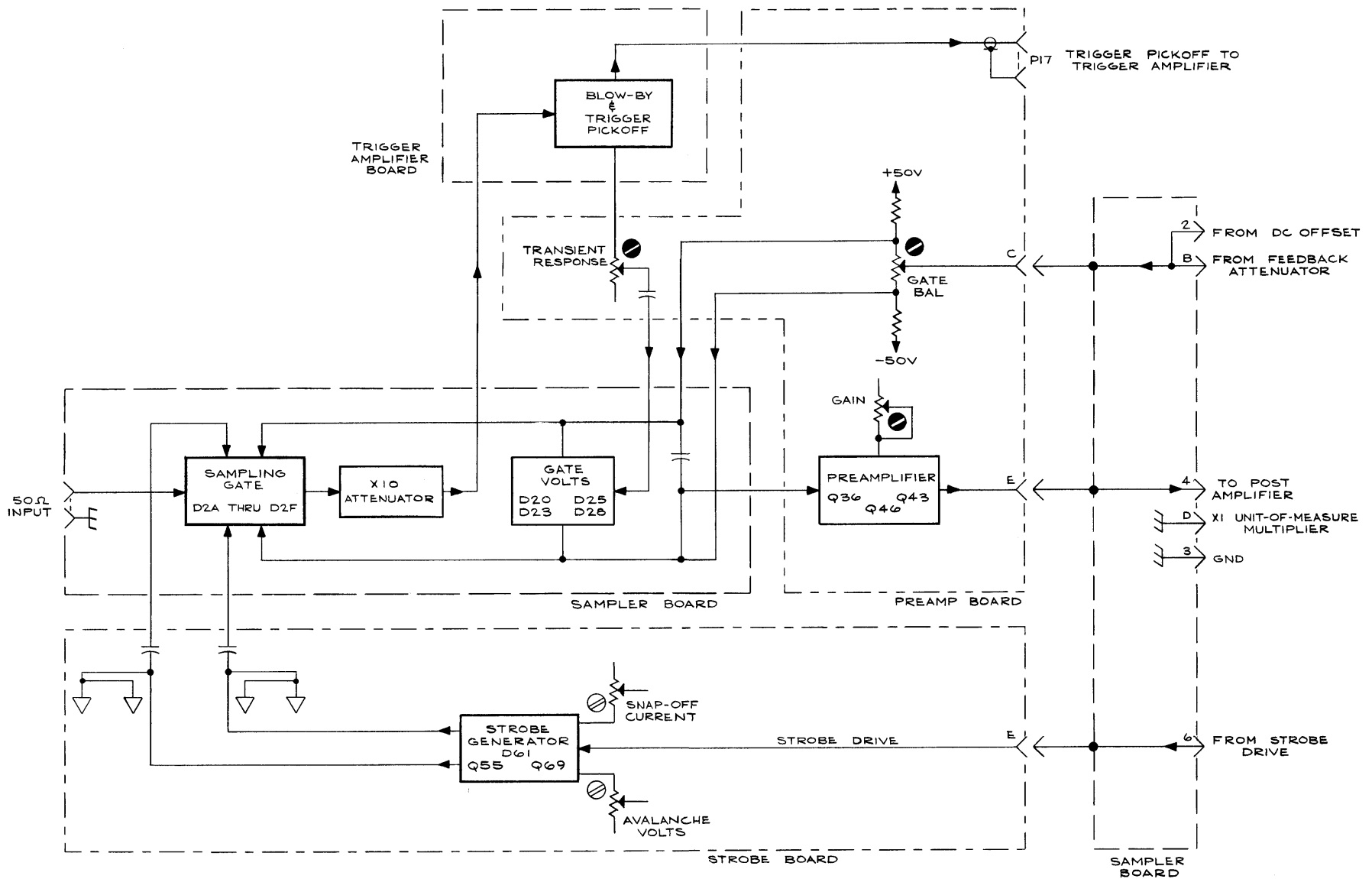

TYPE S-4 SAMPLING HEAD

A

BLOCK DIAGRAM

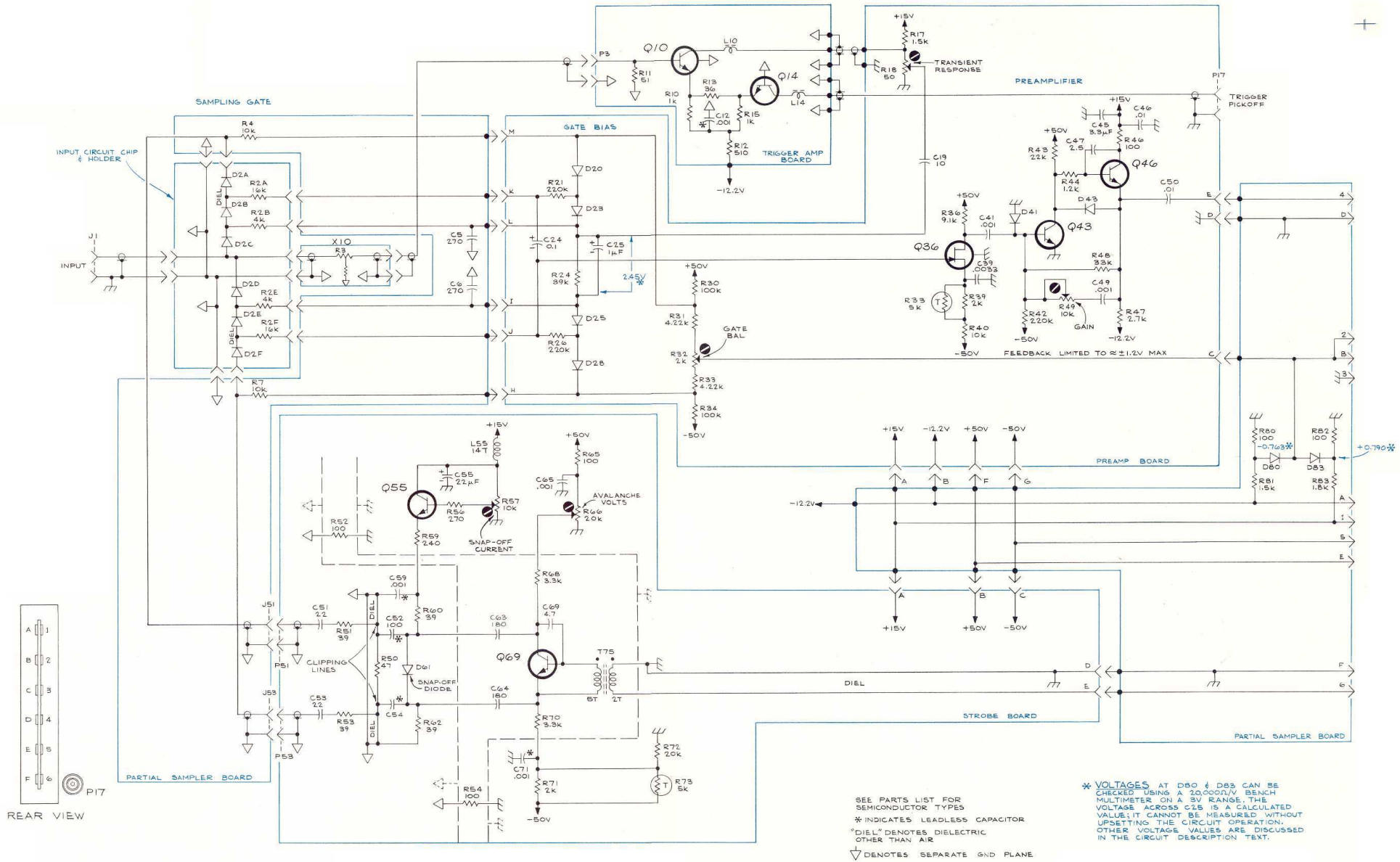

FIG 1 EXPLODED

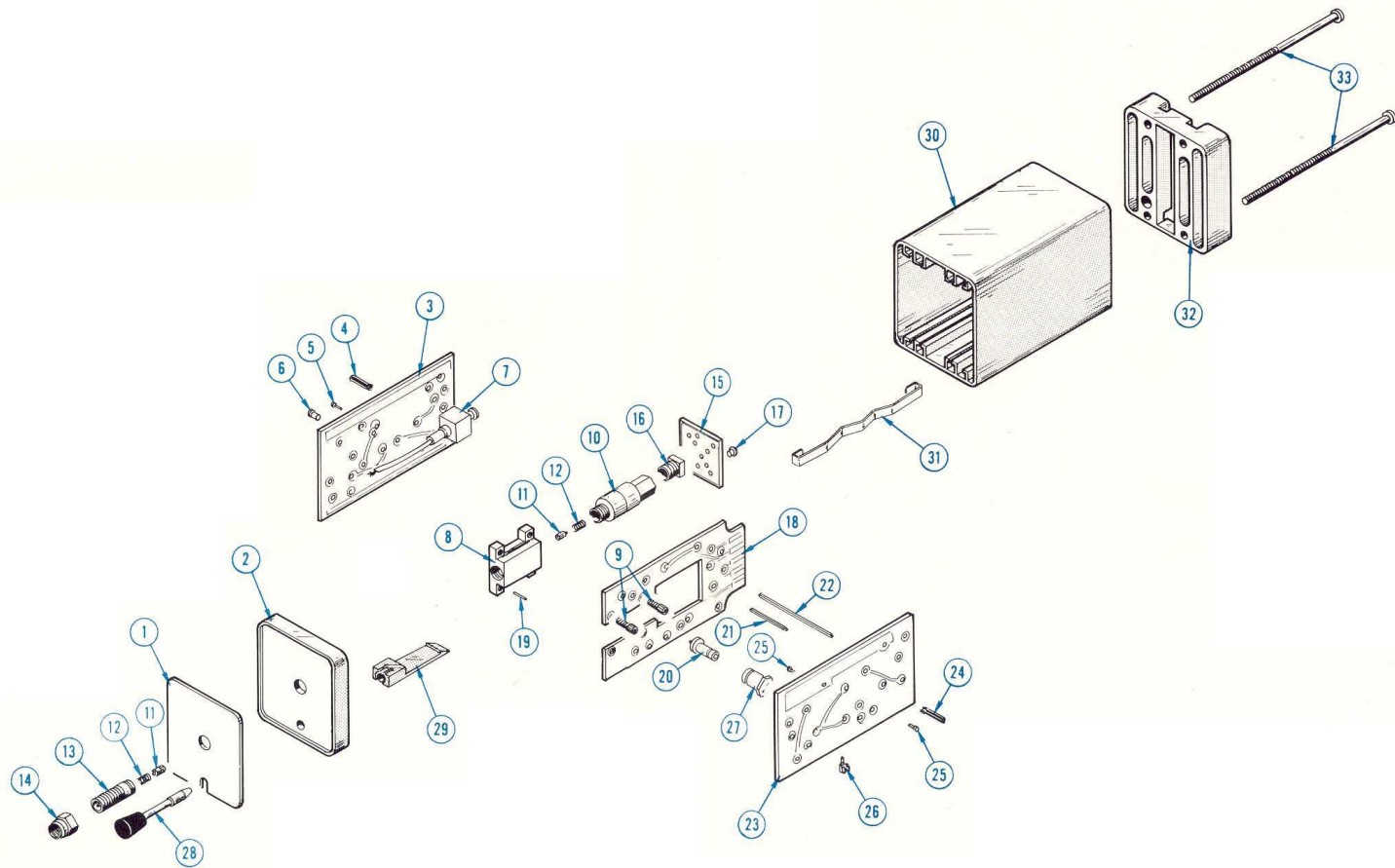

FIG 2 ACCESSORIES

OPTIONAL ACCESSORIES

Fig. & Index No.	Tektronix Part No.	Serial/Model No. Eff	No. Disc	Q † y	Description					
					1	2	3	4	5	
015-1001-00				1						ATTENUATOR, 2X, 3 mm male to female
015-1002-00				1						ATTENUATOR, 5X, 3 mm male to female
015-1004-00				1						TERMINATION, 50 Ω 3 mm female
015-1006-00				1						CABLE, signal, 5 ns, 3 mm male to female
015-1008-00				1						ADAPTER, GR874 to 3 mm female
015-1009-00				1						ADAPTER, "N" type female to 3 mm male
015-1010-00				1						ADAPTER, 7 mm to 3 mm male
015-1012-00				1						ADAPTER, 3 mm female to female
015-1013-00				1						COUPLING CAP, 3 mm female
015-1014-00				1						POWER DIVIDER, "T", 3 mm male
015-1015-00				1						CABLE ASSEMBLY, RF, 3 mm, 5 ns
015-1016-00				1						ADAPTER, "T", female, male, female

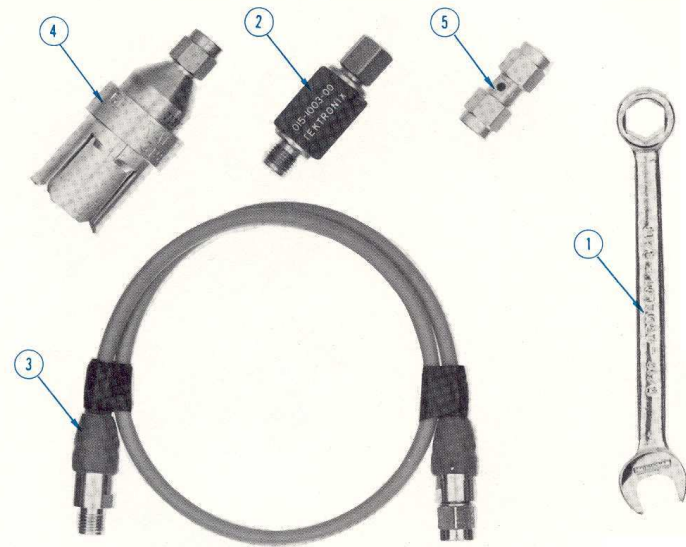

FIG. 2 ACCESSORIES

Fig. & Index No.	Tektronix Part No.	Serial/Model No. Eff	No. Disc	Q † y	Description					
					1	2	3	4	5	
2-1	003-0247-00			1						WRENCH, combination, 5/16 inch
-2	015-1003-00			1						ATTENUATOR, 10X, 3 mm male to female
-3	015-1005-00			1						CABLE, signal, 2 ns, 3 mm male to female
-4	015-1007-00			1						ADAPTER, GR874 to 3 mm male
-5	015-1011-00			1						ADAPTER, 3 mm male to male
	070-0896-00			1						MANUAL, instruction (not shown)

MANUAL CHANGE INFORMATION

At Tektronix, we continually strive to keep up with latest electronic developments by adding circuit and component improvements to our instruments as soon as they are developed and tested.

Sometimes, due to printing and shipping requirements, we can't get these changes immediately into printed manuals. Hence, your manual may contain new change information on following pages.

A single change may affect several sections. Sections of the manual are often printed at different times, so some of the information on the change pages may already be in your manual. Since the change information sheets are carried in the manual until ALL changes are permanently entered, some duplication may occur. If no such change pages appear in this section, your manual is correct as printed.

TYPE S-4

TEXT CORRECTION

Section 3 Circuit Description

Page 3-2 right column

CHANGE: the first two sentences of the next to the last paragraph to read as follows:

 Ringing of the Snap-off diode and the clipping lines is prevented mainly by R50 which is directly across the lines ends.

C1/169

TEXT CORRECTION

Section 2 Operating Instructions

Any time the rigid coaxial cable is identified as semi-rigid, remove the word "semi" from the text.

Page 2-8 CAUTION

REPLACE: the present CAUTION text with the following:

CAUTION

The two coaxial lines listed under part numbers 015-1015-00 and 015-1005-00 must be treated with care to obtain maximum life and least signal distortion. The rigid line may not have its shape changed and still have the propagation delay and Z_0 guaranteed. In cases where the line is not used at its maximum performance limits, small amounts of bending can be made providing mating connectors are on each end before bending. If bent to a curve radius of 1-1/2 inches, the line may be made totally inoperative. The flexible cable must not be given a bend radius less than 10 times its OD, or approximately 2-1/4 inches. Flexible cables may suffer outer conductor breakage by tighter bending. Few Flexures assure longer life.

Section 3 Circuit Description

Page 3-5 Column 1

DELETE: put a period after R38 in second sentence and delete remainder of the second sentence.

CHANGE: the third sentence to read:

A total of 4.4 mA channel current passes from the +50 volt supply through R36, Q36, R38 and R40 to the -50 volt supply.

Page 3-5 Column 2

INSERT: the following sentence between the second and third sentences in paragraph two:

R37 and R39 provide temperature compensation to stabilize loop gain.

Section 4 Maintenance

Page 4-5 Fig. 4-6

REPLACE: the present Fig. 4-6 with the one below:

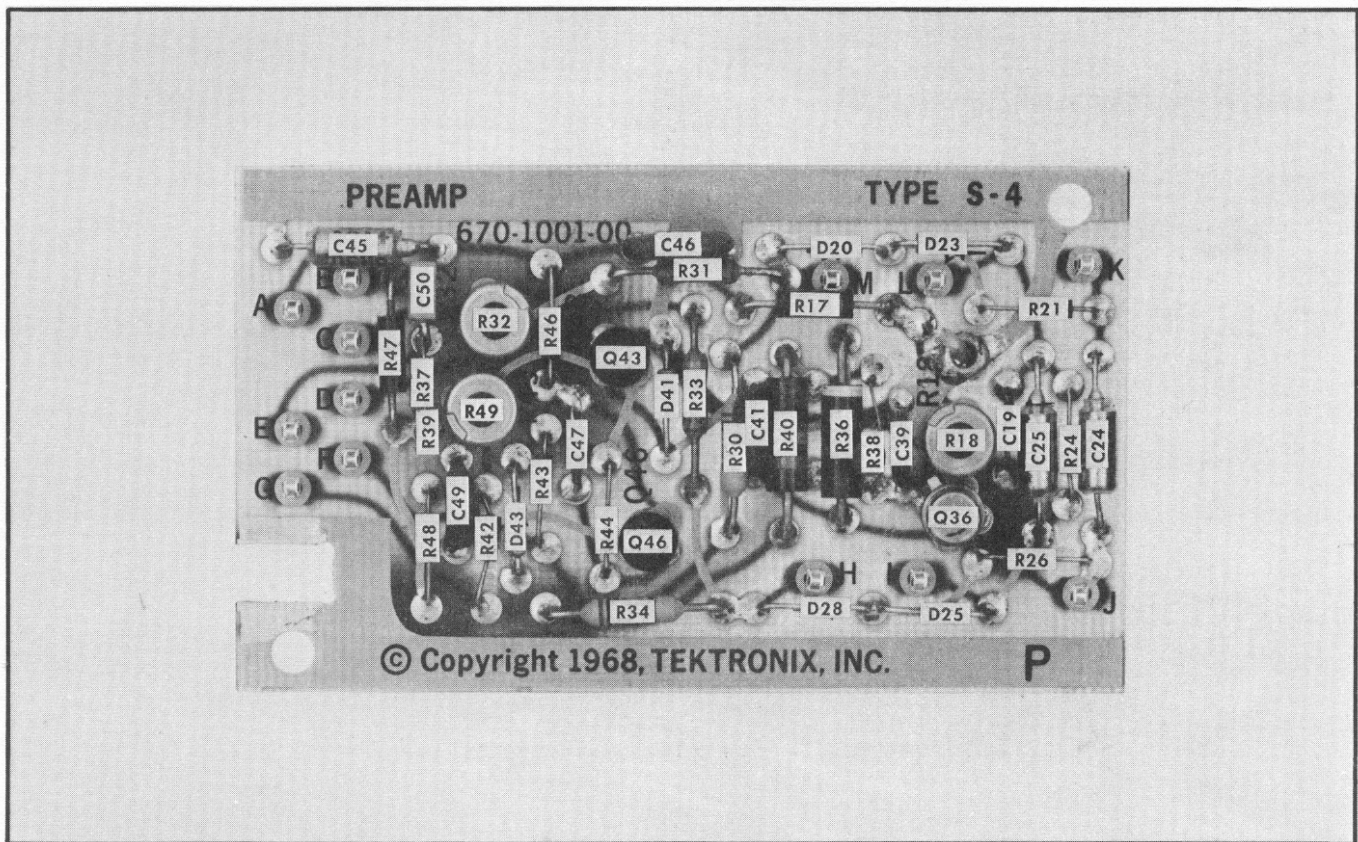

Section 5 Performance Check/Calibration

CHANGE: all references to solid coaxial cable to rigid coaxial cable.

ELECTRICAL PARTS LIST CORRECTION

CHANGE TO:

C50	283-0155-00	0.01 μ F	Cer	100 V	
R38	307-0127-00	1 k Ω	Thermal		
R39	307-0122-00	50 Ω	Thermal		
R72	315-0124-00	120 k Ω	1/4 W		5%

ADD:

R37	317-0390-00	39 Ω	1/8 W		5%
-----	-------------	-------------	-------	--	----

SCHEMATIC CORRECTION

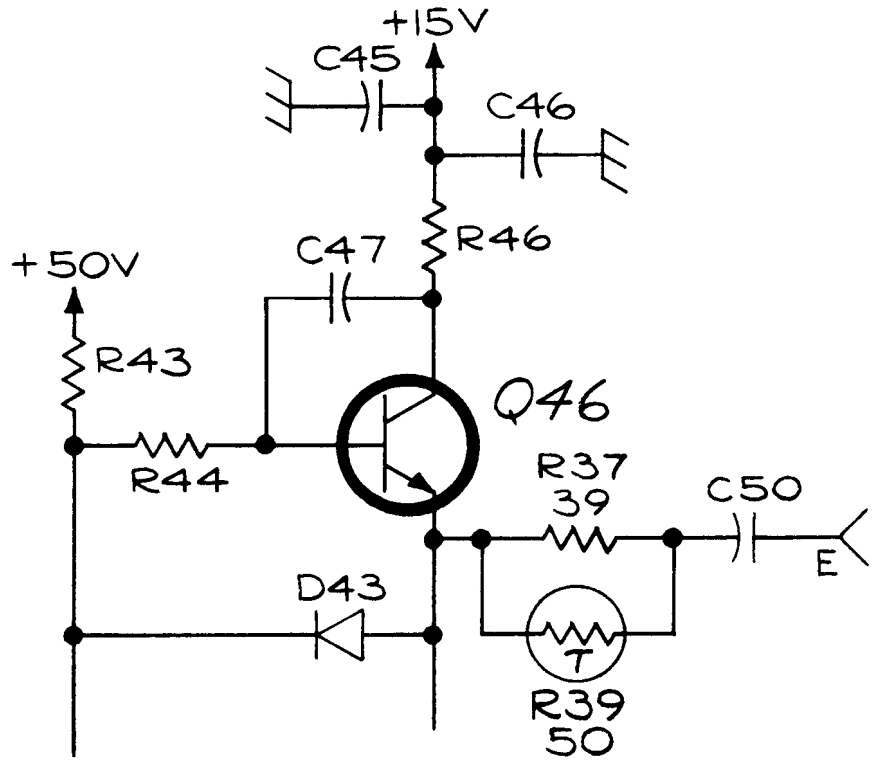
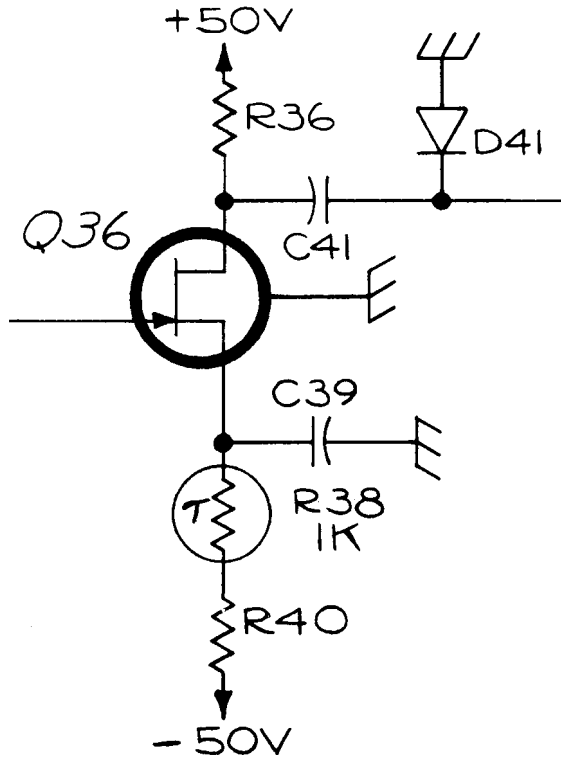

PARTIAL SAMPLING HEAD